

SITE ADDRESS

OM COURTYARD
Turn From - Railway Bridge / Hotel Anand Palace,
Nr. Hathijan Circle, Vinzol,Ahmedabad- 382445.

DEVELOPER :



**AMRUT
INFRACON LLP**

ARCHITECT :



STRUCTURE ENGINEER :

**ANKITBHAI
MISTRY**

RERA NO. : _____
WEBSITE : www.gujrera.gujarat.gov.in



OM COURTYARD

3 & 4 BHK BHARATIYA STYLED VILLAS

3 BHK



4 BHK



LAYOUT PLAN

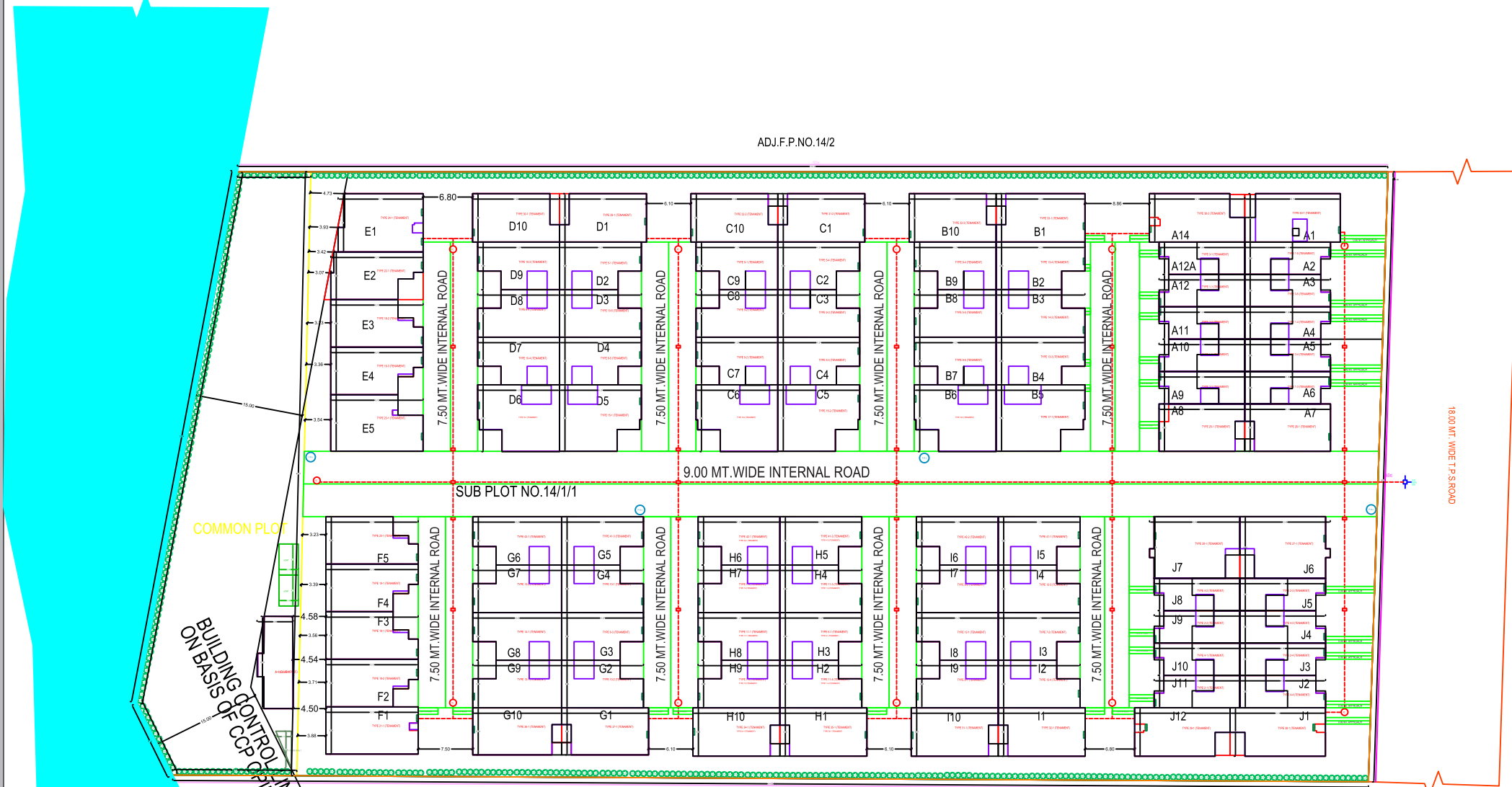

ADJ.F.P.NO.7/2

BUILDING CONTROL MEAS PER CGDCR CL-17.12
ON BASIS OF CCP OPINION: 07.576 DATE: 01/03/2021

UNIT PLAN TYPE 1 (A-2,A-4,A-6,A-10,A-12)

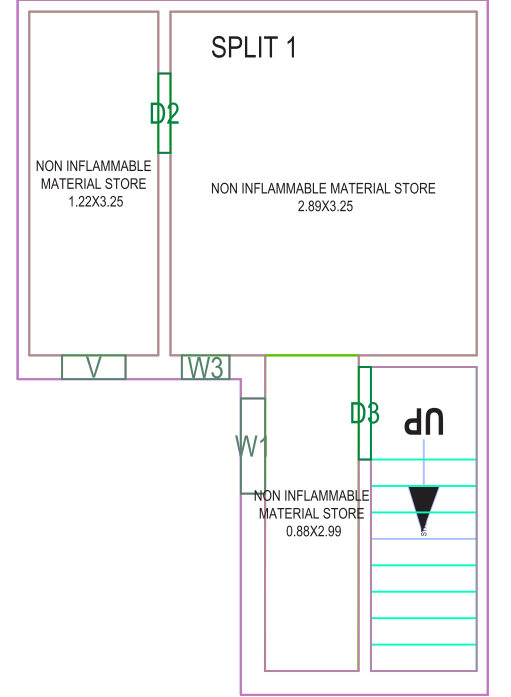

BASEMENT FLOOR PLAN

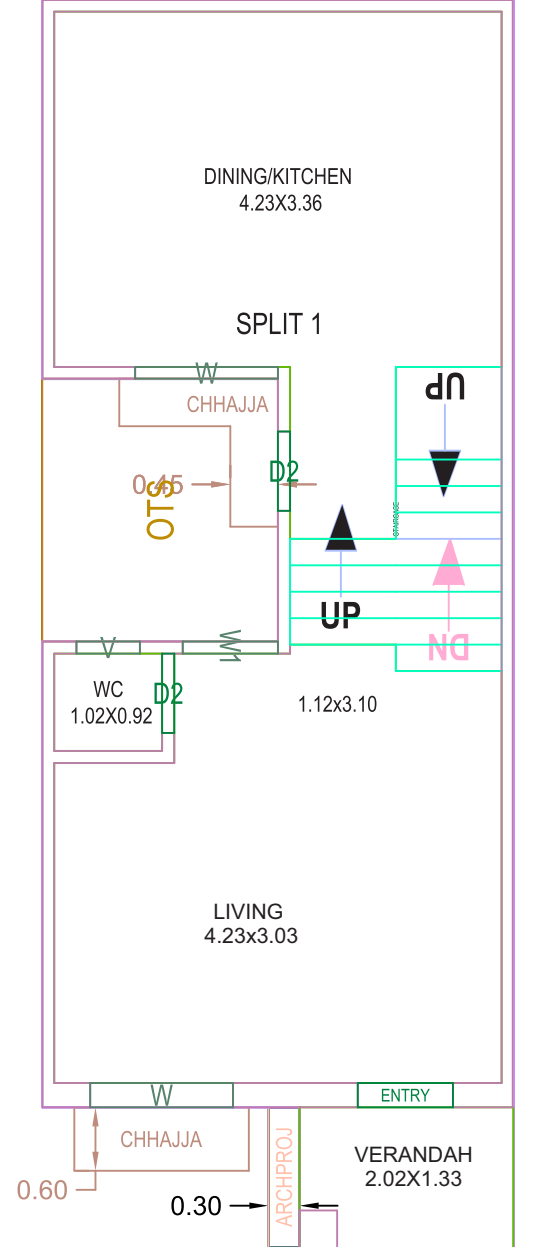

GROUND FLOOR PLAN

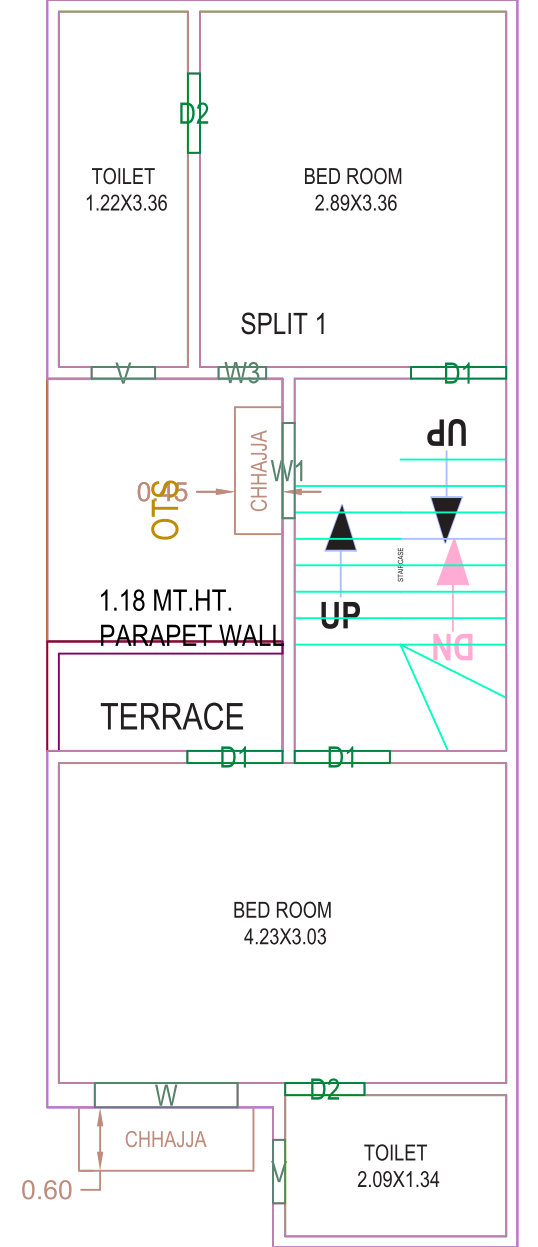

FIRST FLOOR PLAN

**UNIT PLAN
TYPE 2 (J-3,J-5,J-9,J-11)**

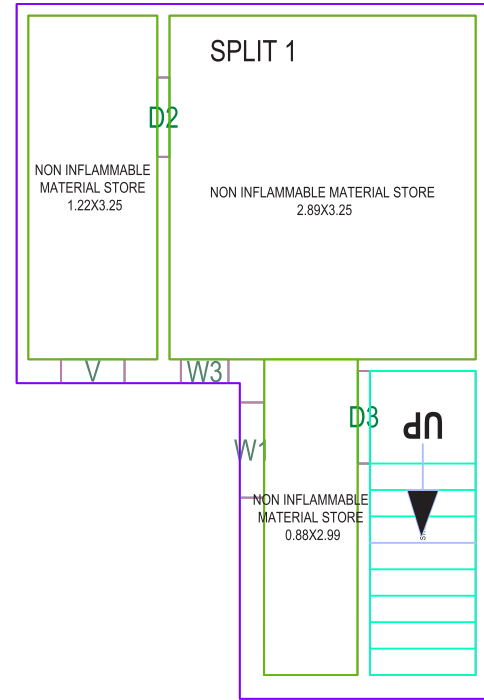

BASEMENT FLOOR PLAN

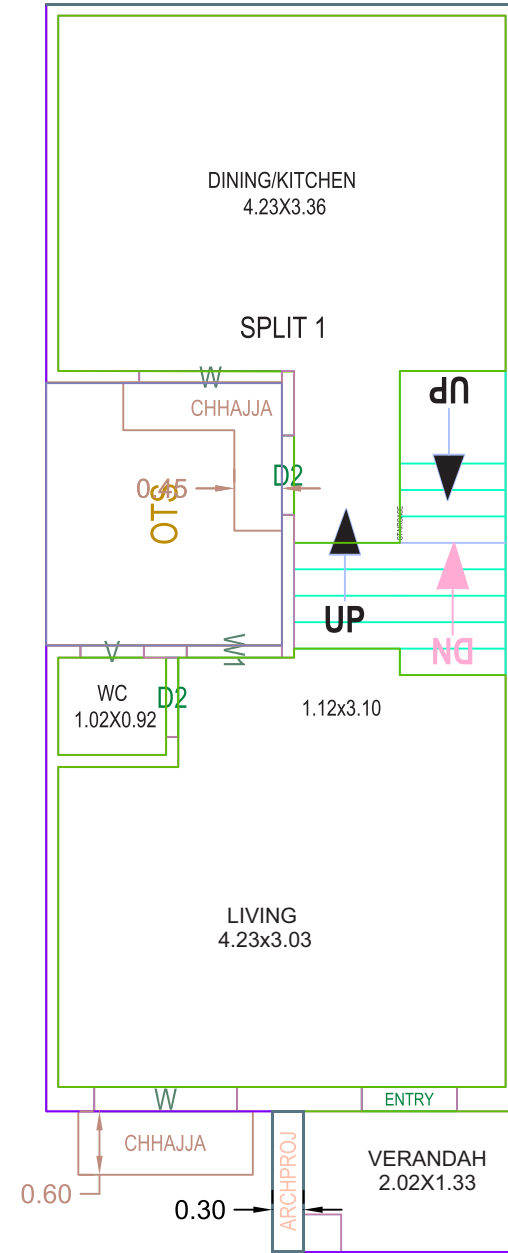

GROUND FLOOR PLAN

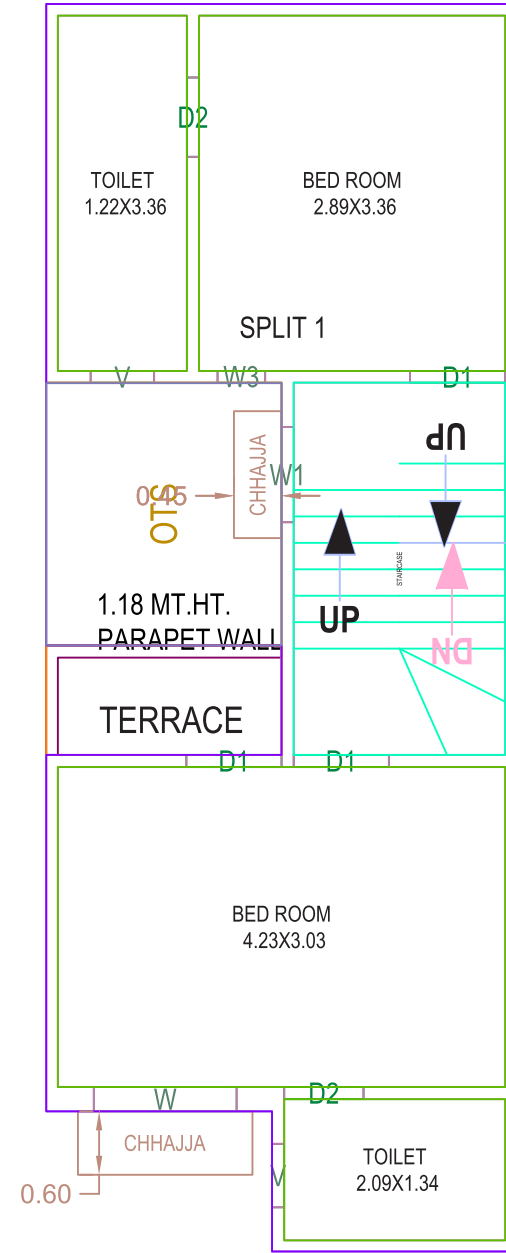

FIRST FLOOR PLAN

**UNIT PLAN
TYPE 3 (A-3,A-5,A-9,A-11,A12A)**

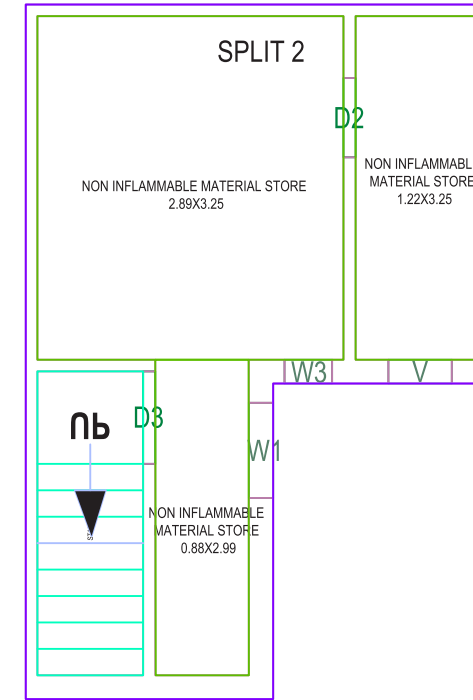

BASEMENT FLOOR PLAN

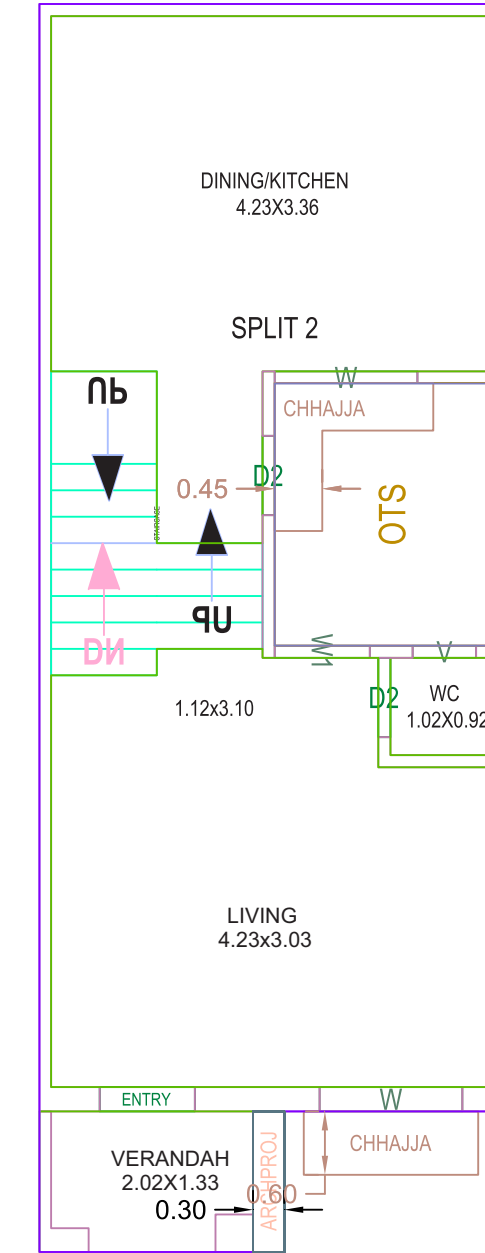

GROUND FLOOR PLAN

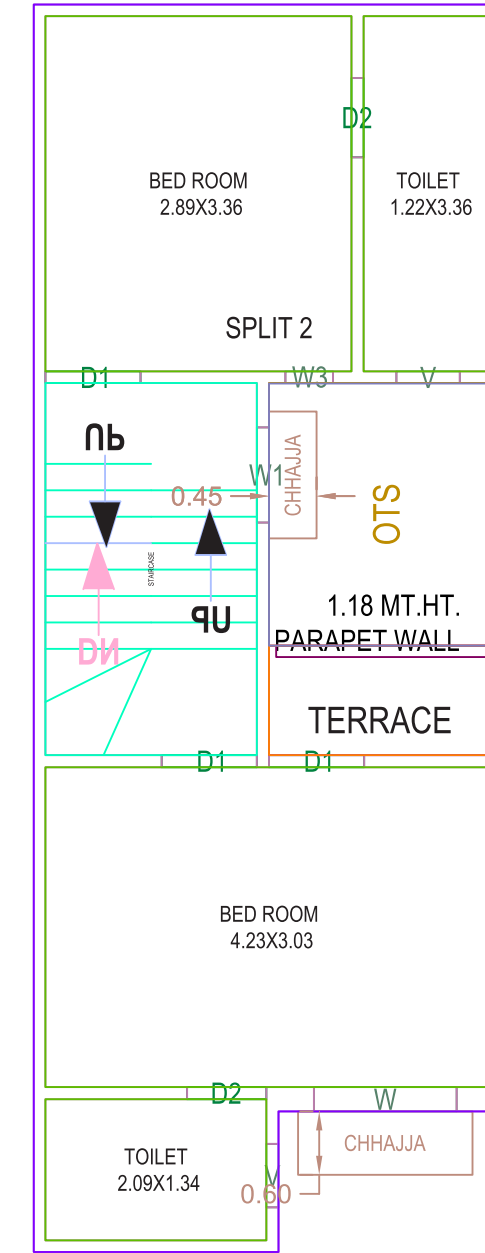

FIRST FLOOR PLAN

**UNIT PLAN
TYPE 4 (J-2,J-4,J-8,J-10)**

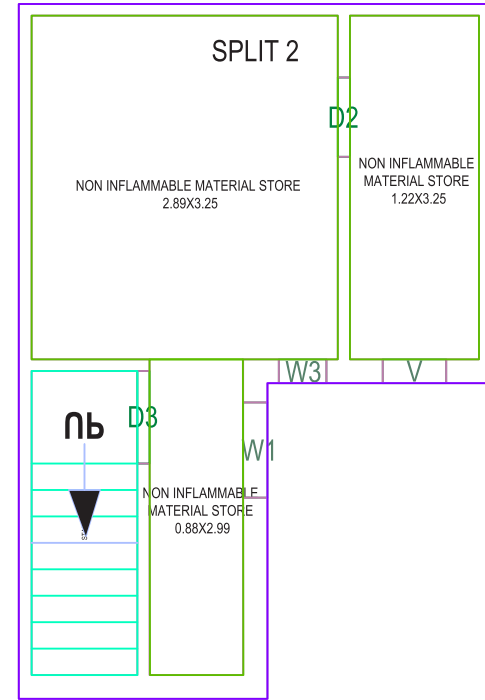

BASEMENT FLOOR PLAN

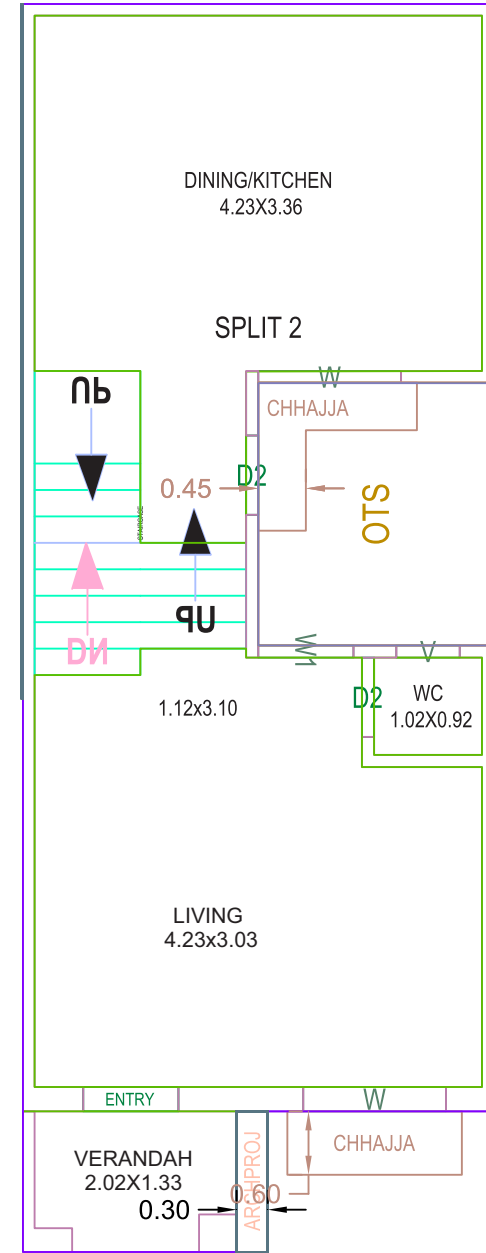

GROUND FLOOR PLAN

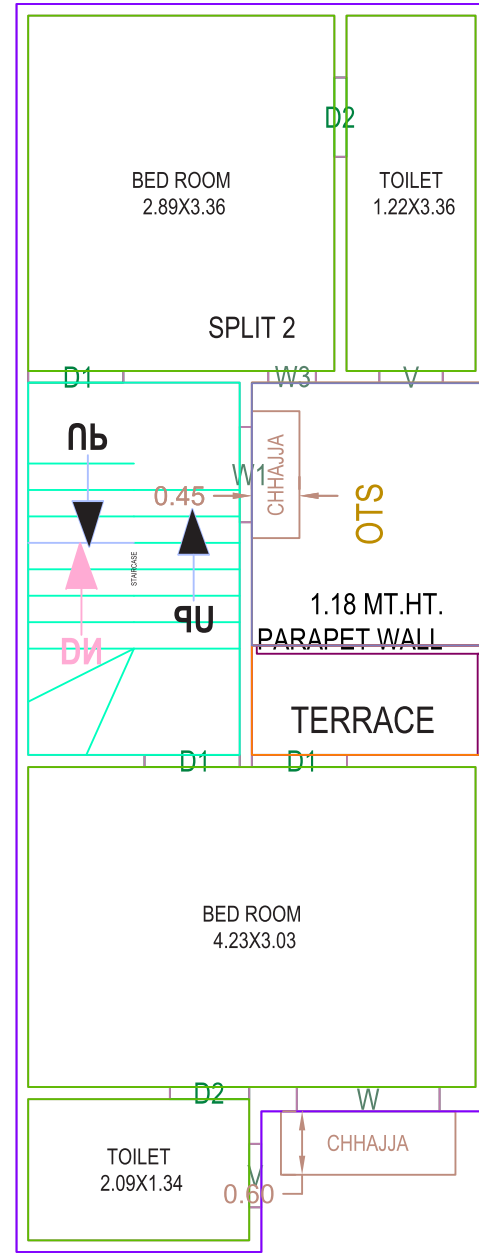

FIRST FLOOR PLAN

**UNIT PLAN
TYPE 5 (B-8,C-2,C-4,C-8,D-2)**

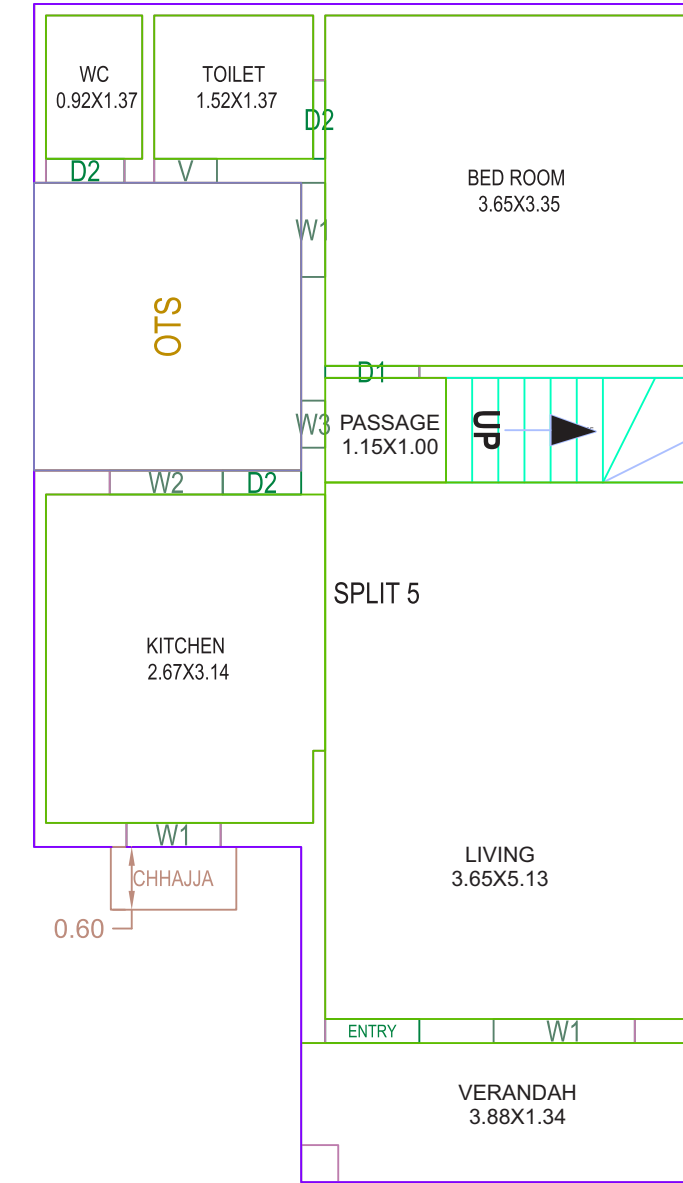

GROUND FLOOR PLAN

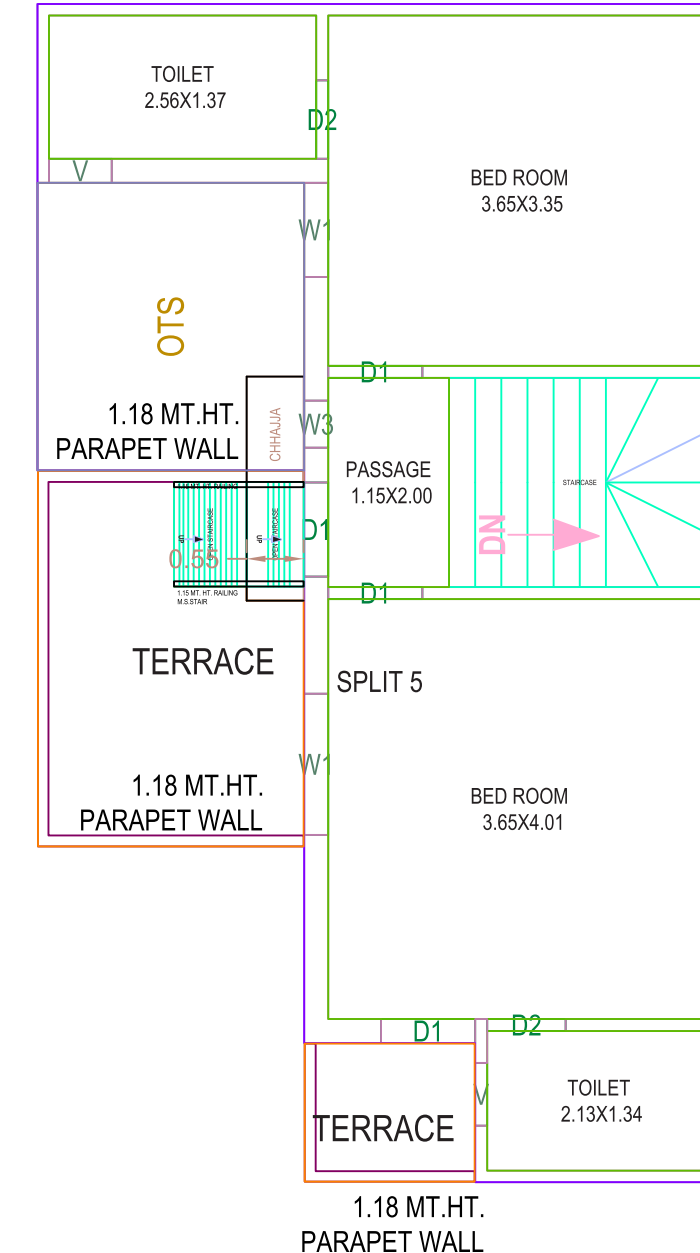

FIRST FLOOR PLAN

**UNIT PLAN
TYPE 6 (D-4,D-8,G-3,H-3)**

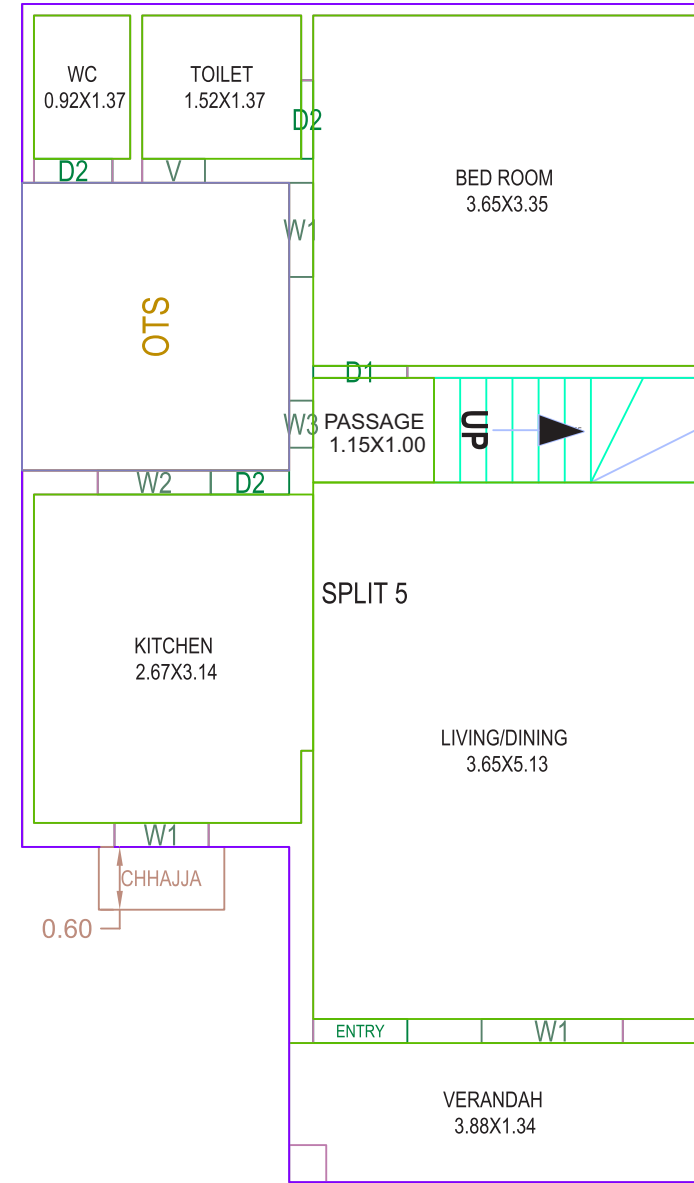

GROUND FLOOR PLAN

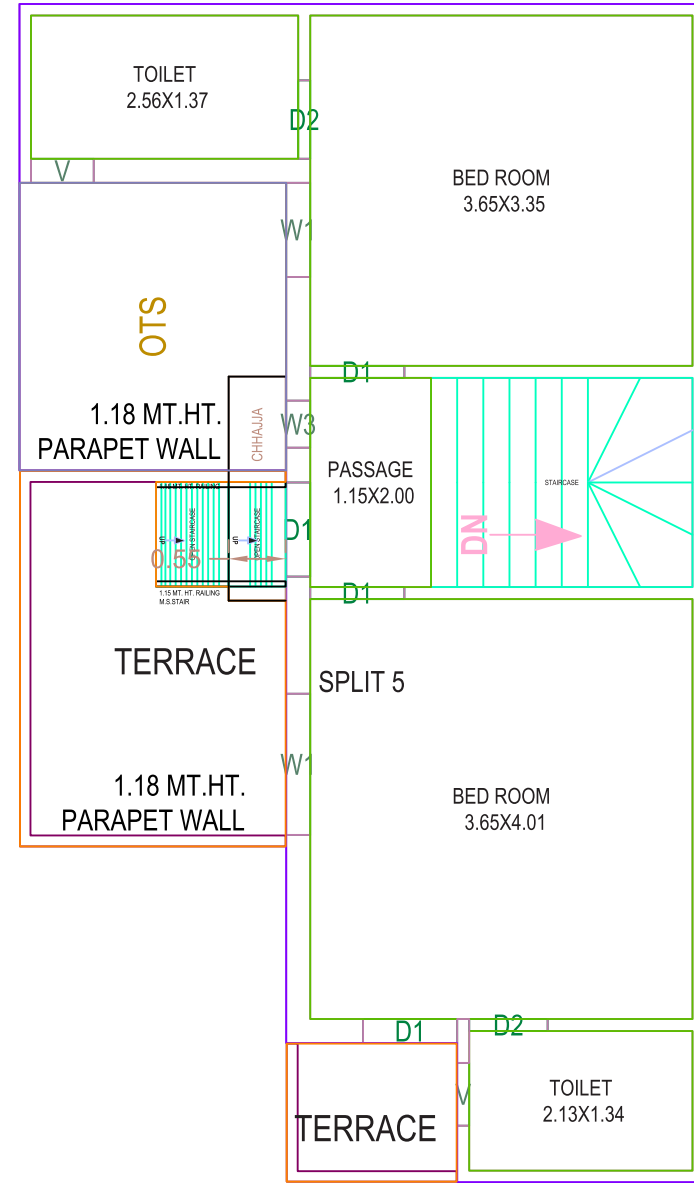

FIRST FLOOR PLAN

**UNIT PLAN
TYPE 7 (H-7,H-9,I-3)**

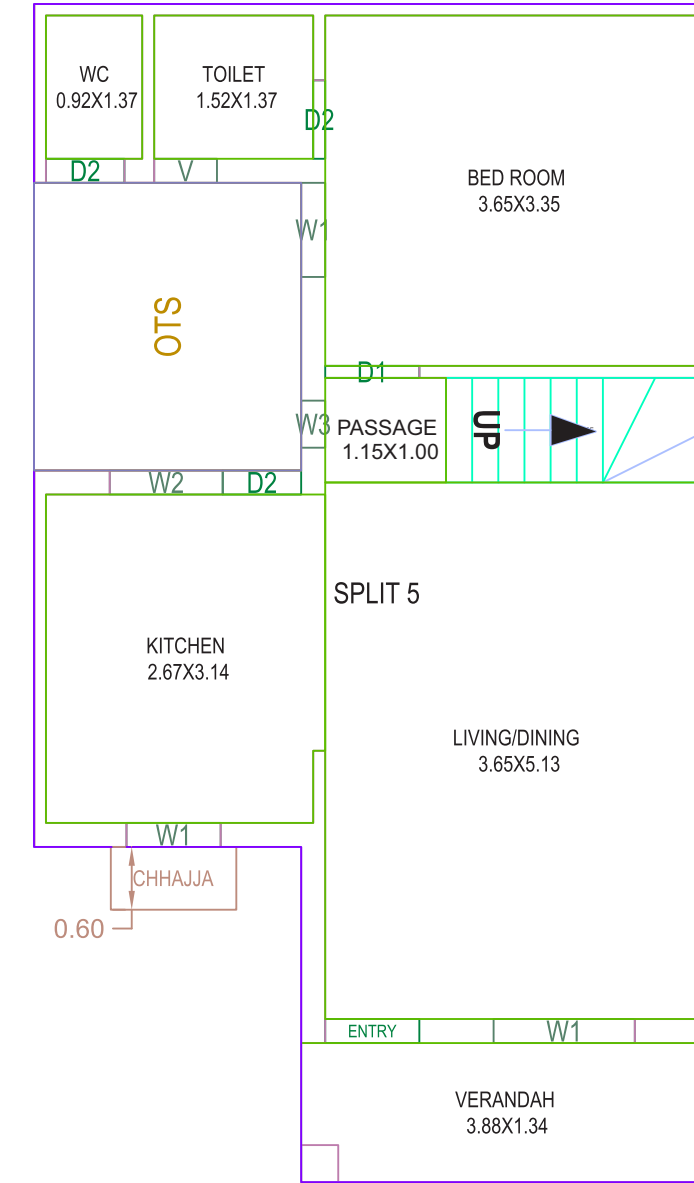

GROUND FLOOR PLAN

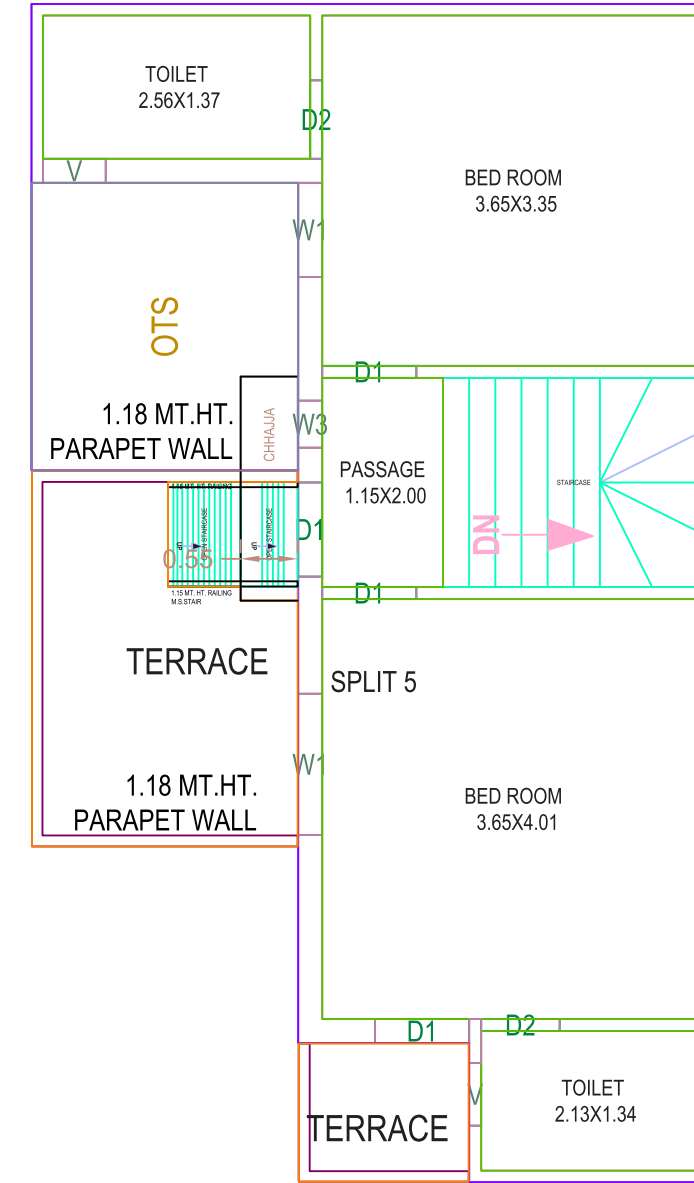

FIRST FLOOR PLAN

**UNIT PLAN
TYPE 8 (I-7,I-9)**

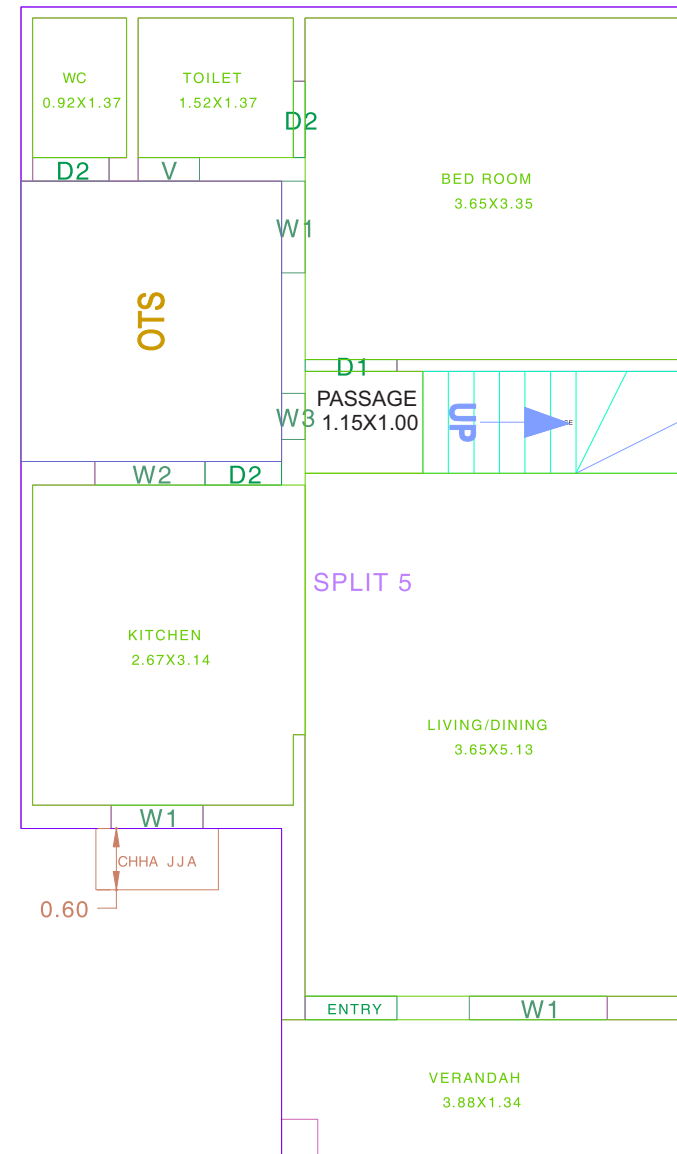

GROUND FLOOR PLAN

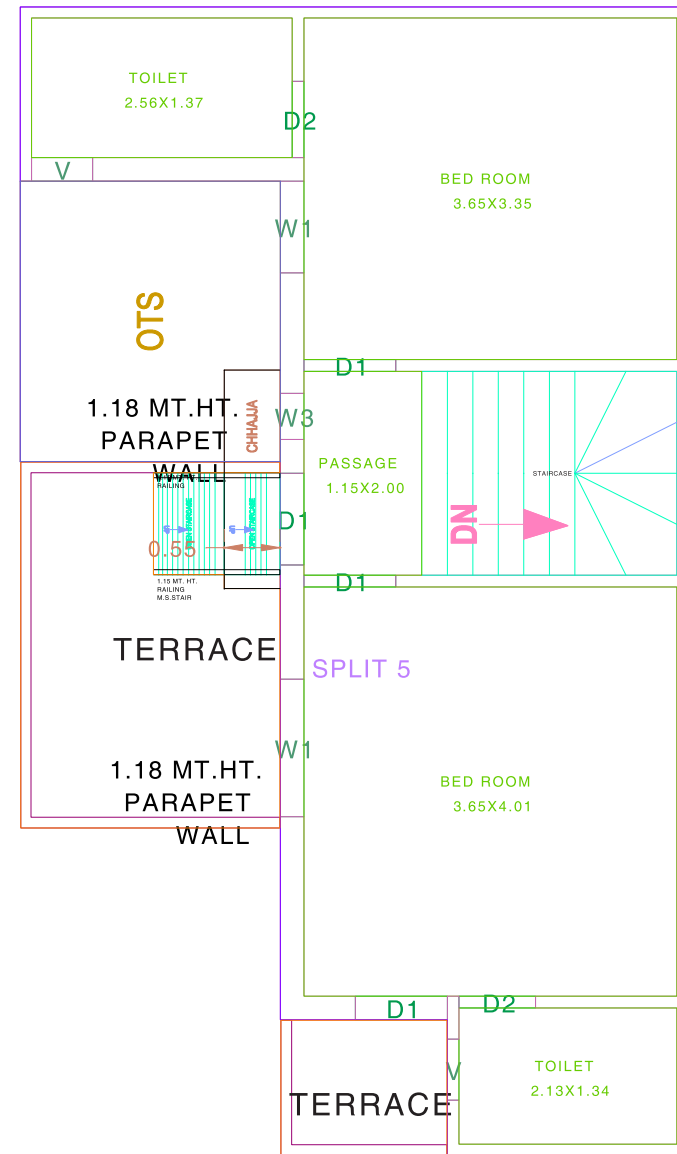

1.18 MT.HT.
PARAPET
WALL

FIRST FLOOR PLAN

**UNIT PLAN
TYPE 9 (B-7,B-9,C-3,C-7,C-9)**

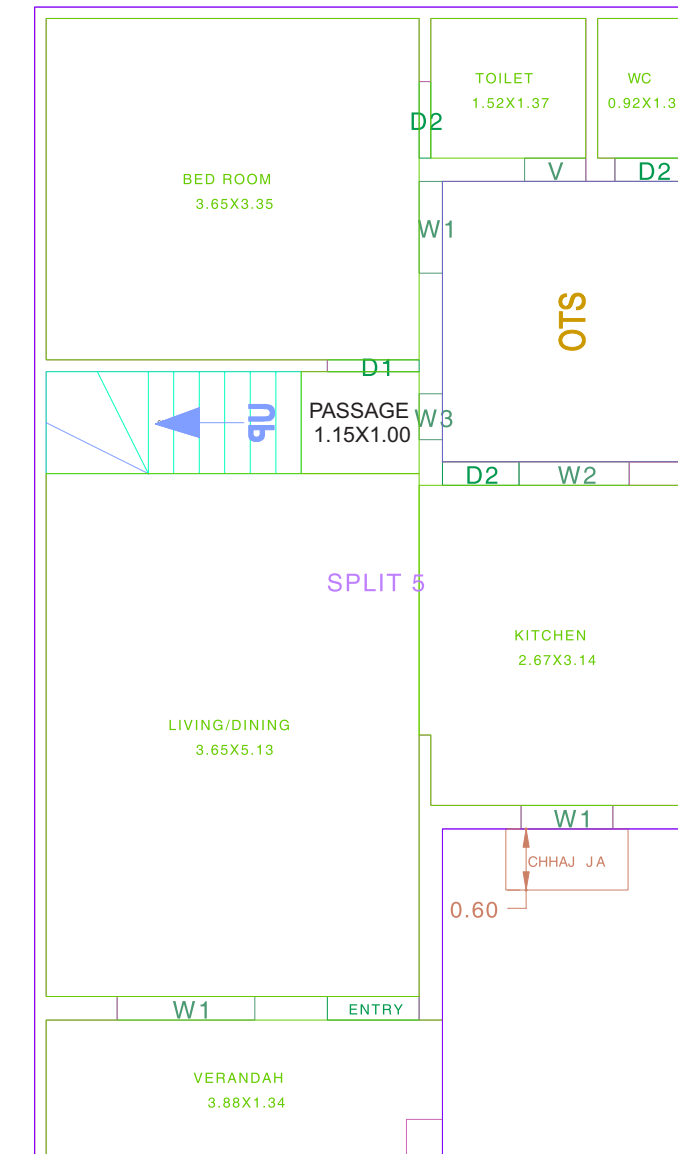

GROUND FLOOR PLAN

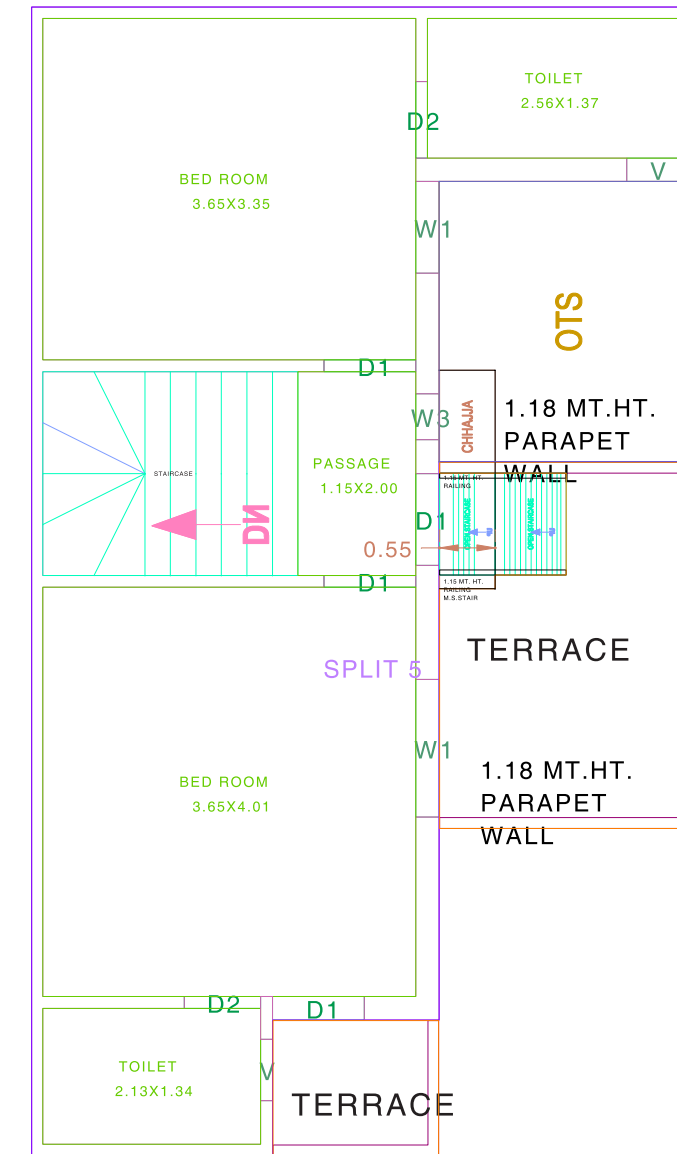

1.18 MT.HT.
PARAPET
WALL

FIRST FLOOR PLAN

**UNIT PLAN
TYPE 10 (D-3,D-7,D-9,G-2,G-4)**

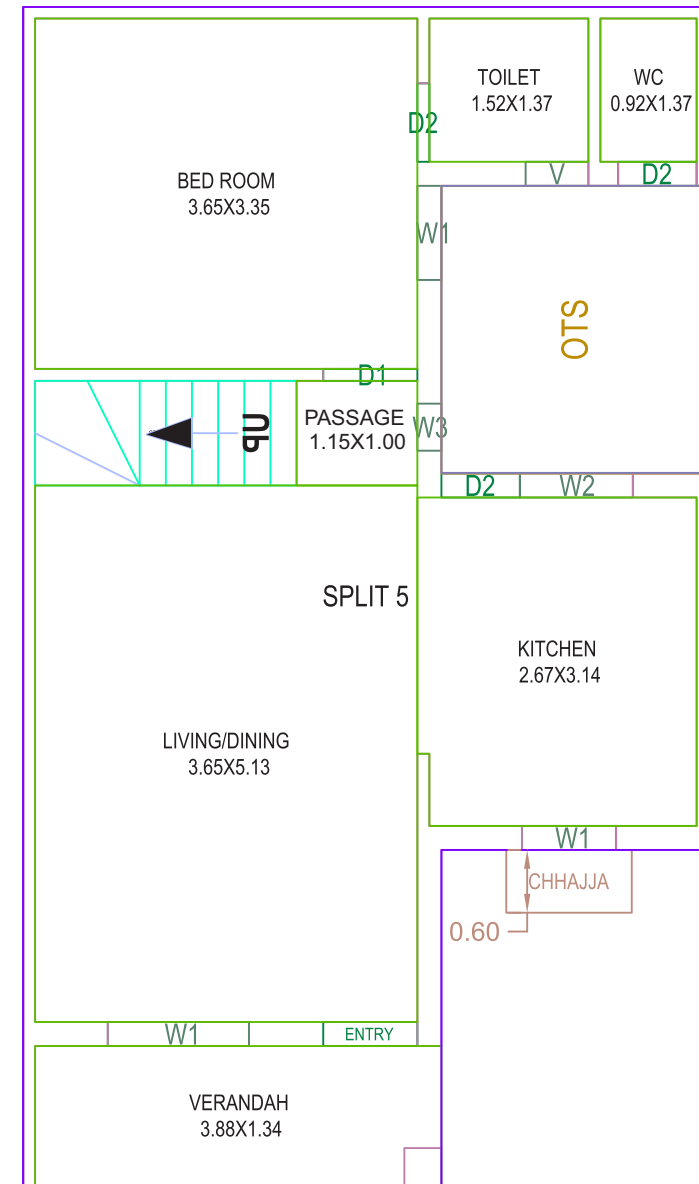

GROUND FLOOR PLAN

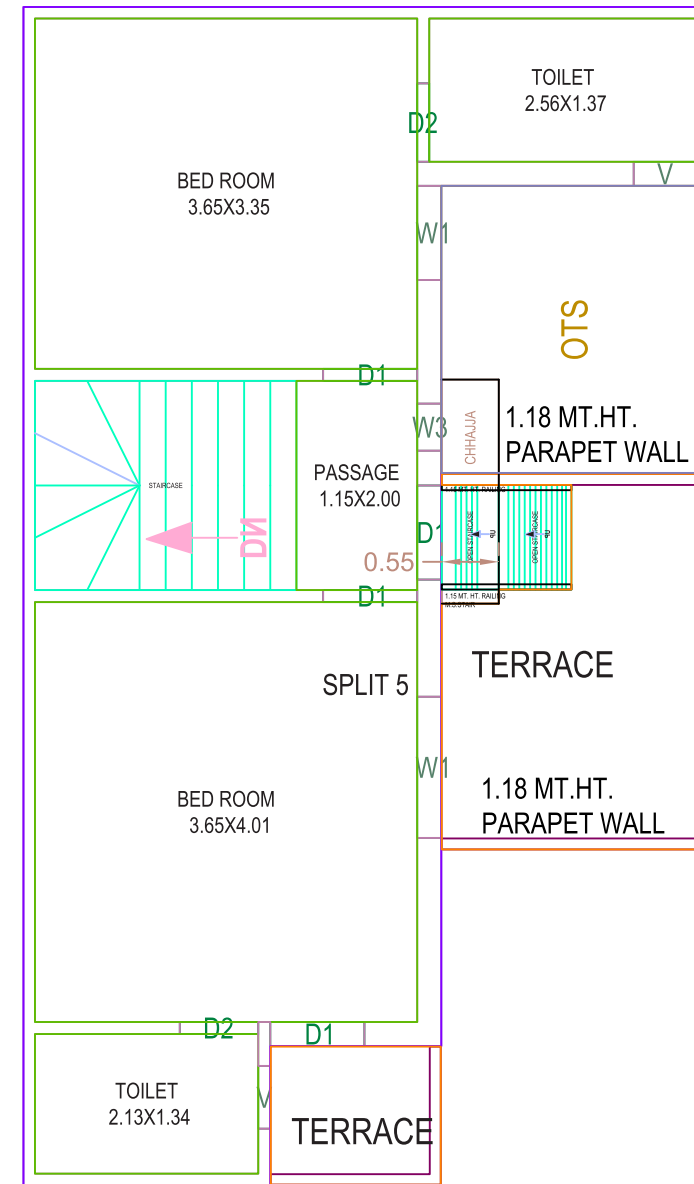

1.18 MT.HT.
PARAPET WALL

FIRST FLOOR PLAN

**UNIT PLAN
TYPE 11 (H-2,H-4,H-8)**

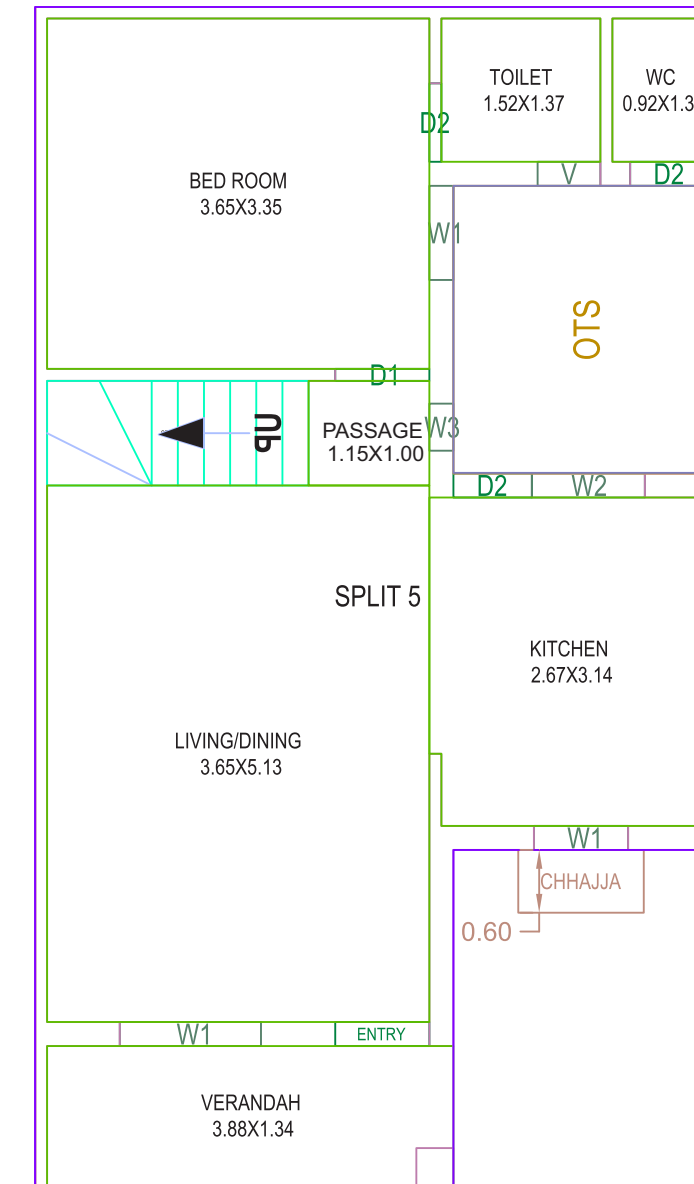

GROUND FLOOR PLAN

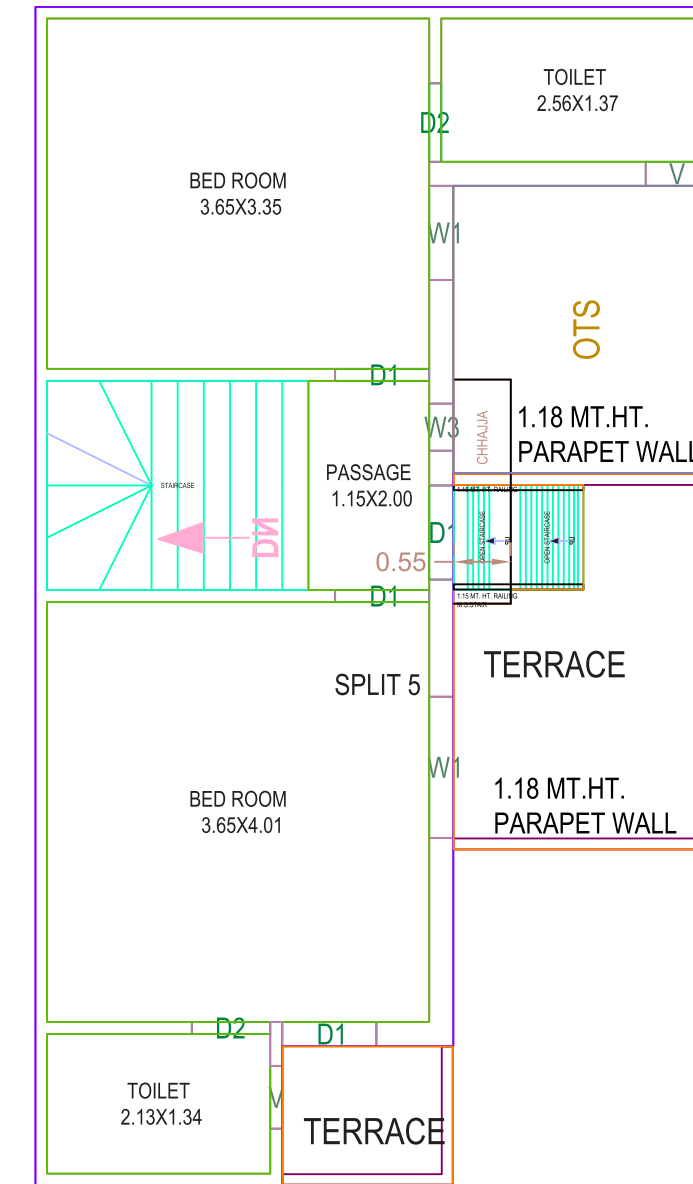

1.18 MT.HT.
PARAPET WALL

FIRST FLOOR PLAN

**UNIT PLAN
TYPE 12 (I-2,I-4,I-8)**

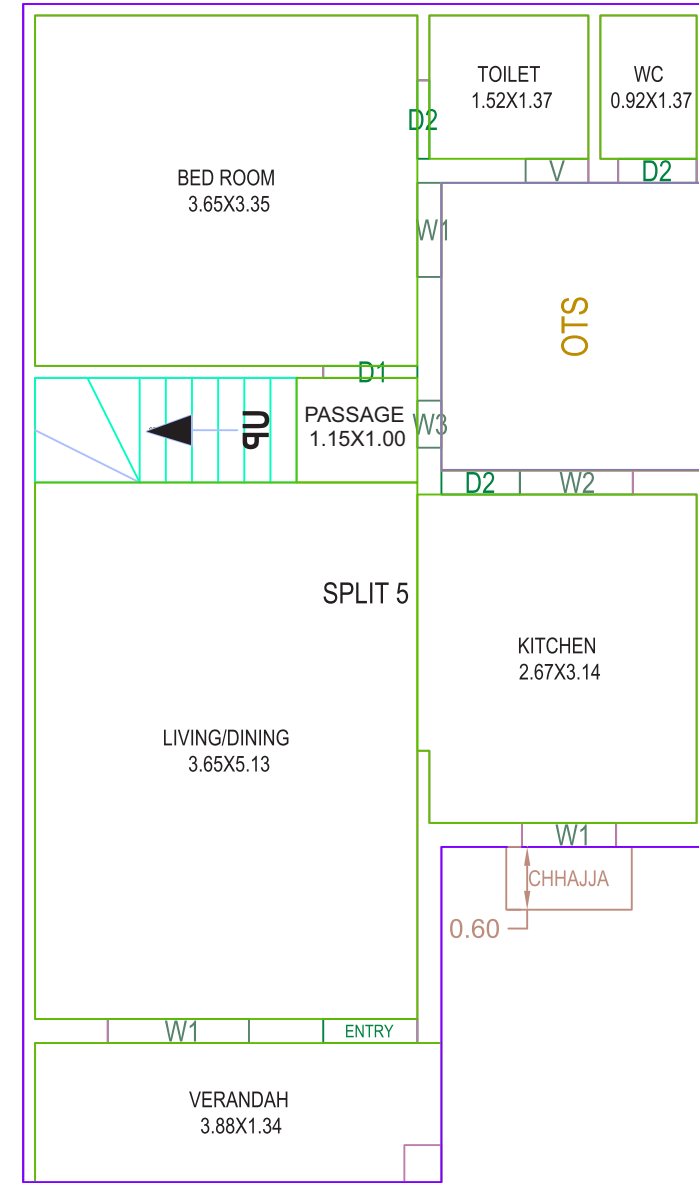

GROUND FLOOR PLAN

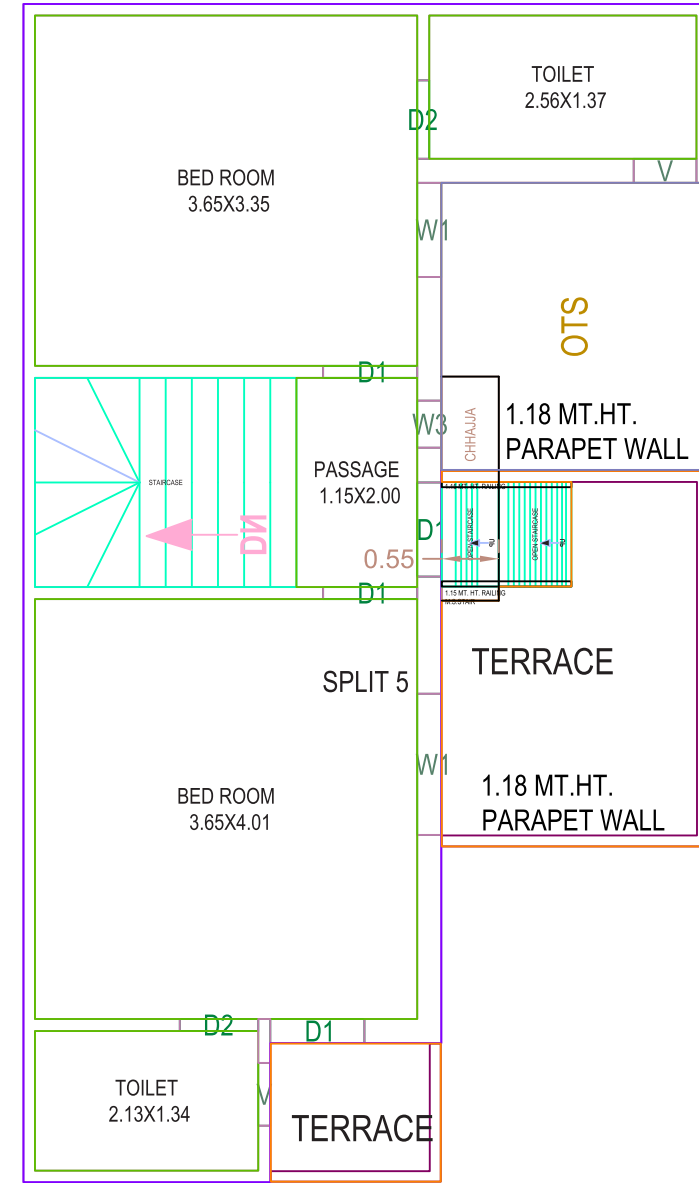

1.18 MT.HT.
PARAPET WALL

FIRST FLOOR PLAN

**UNIT PLAN
TYPE 13 (B-2,B-4,G-7,G-9)**

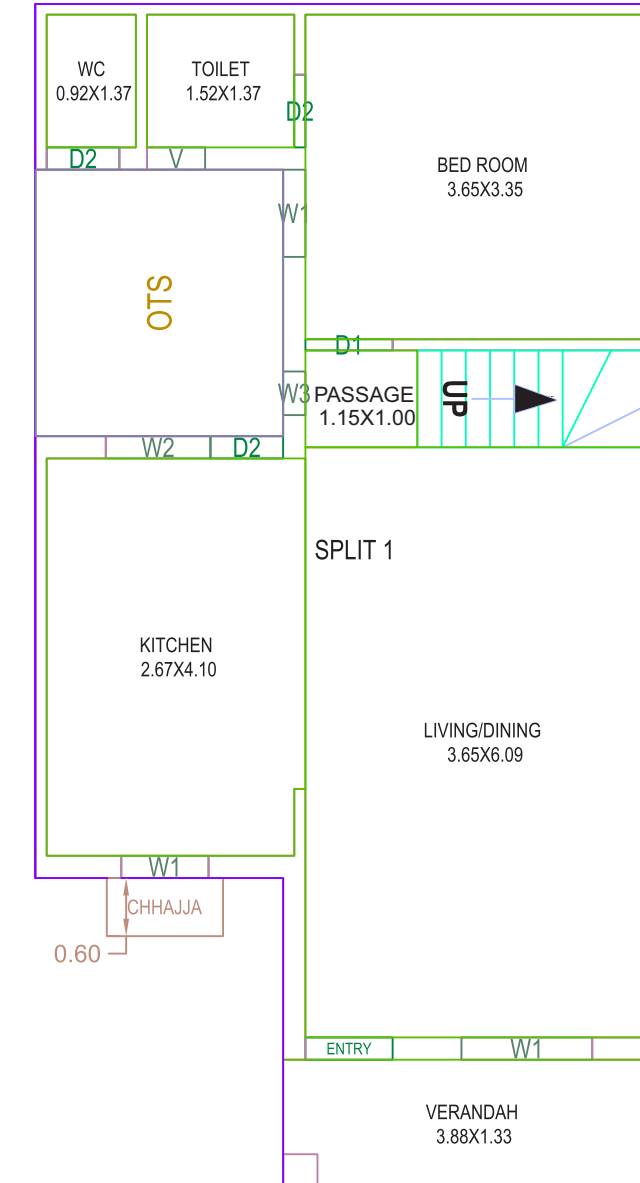

GROUND FLOOR PLAN

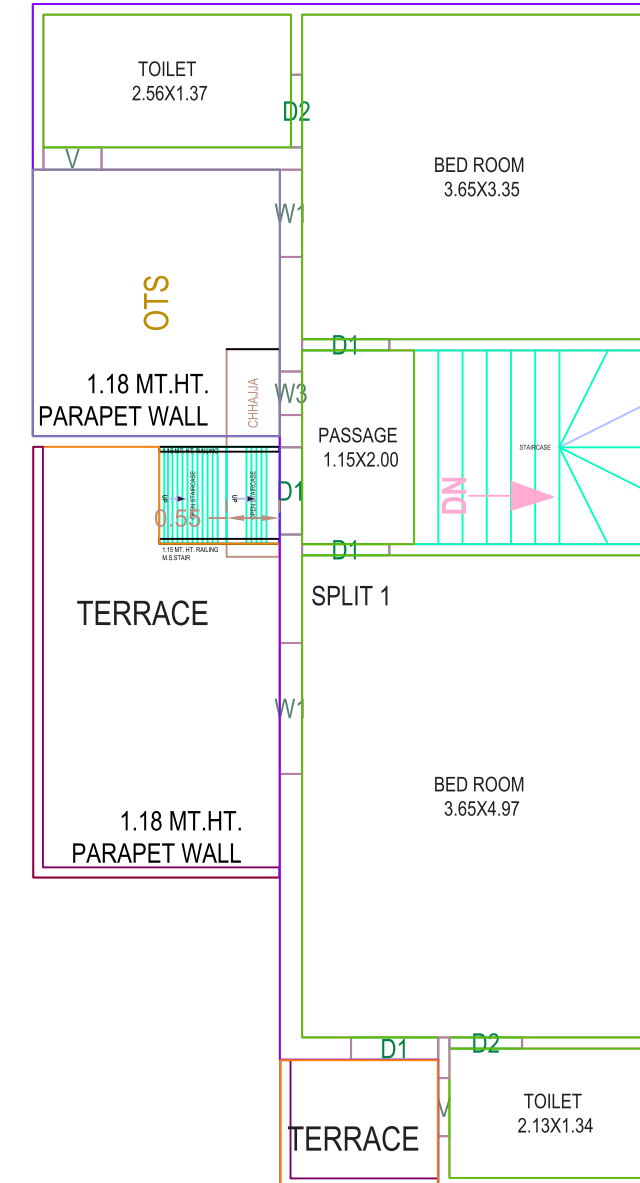

1.18 MT.HT.
PARAPET WALL

FIRST FLOOR PLAN

**UNIT PLAN
TYPE 14 (B-3,G-8)**

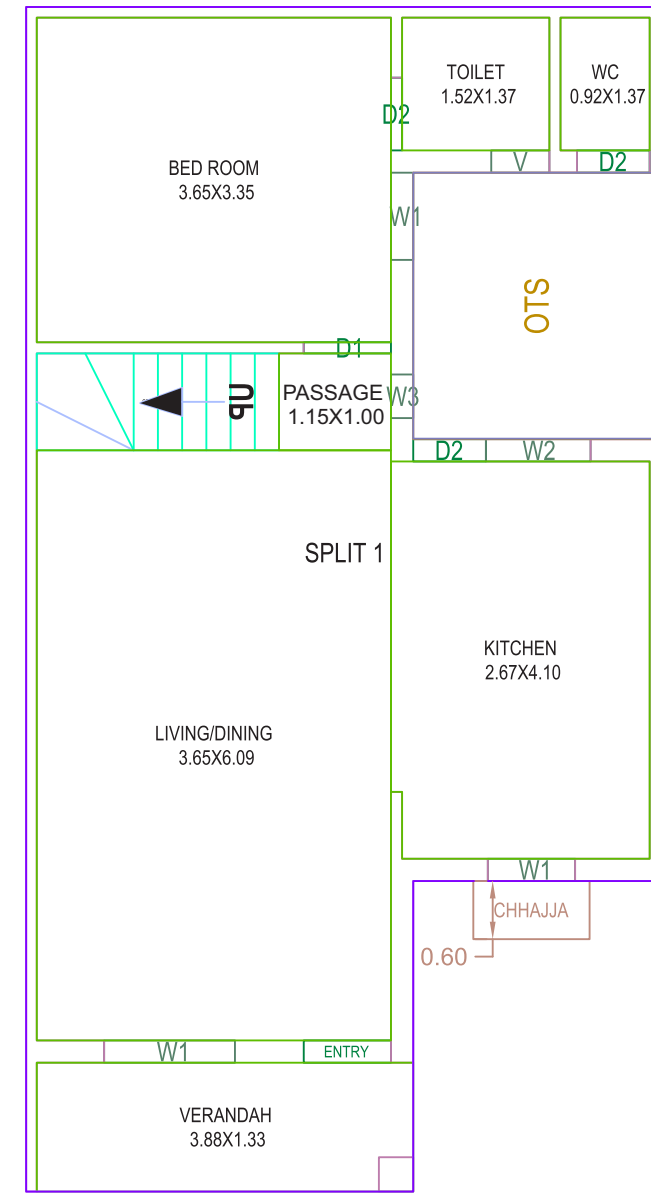

GROUND FLOOR PLAN

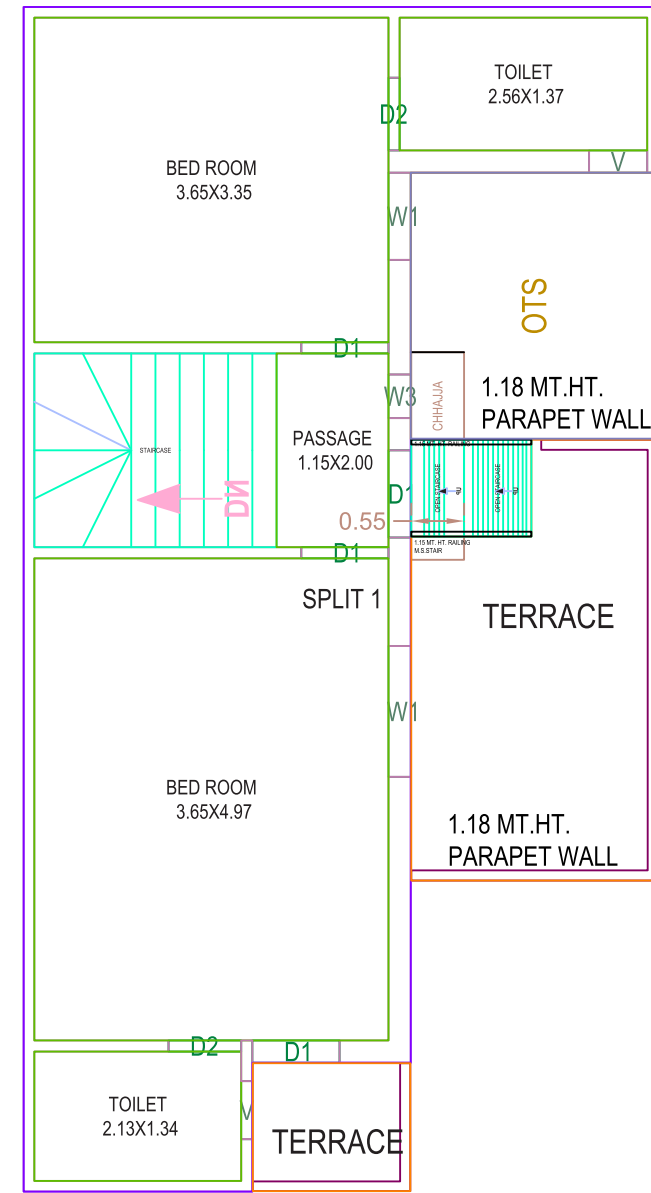

FIRST FLOOR PLAN

**UNIT PLAN
TYPE 15 (C-5,D-5)**

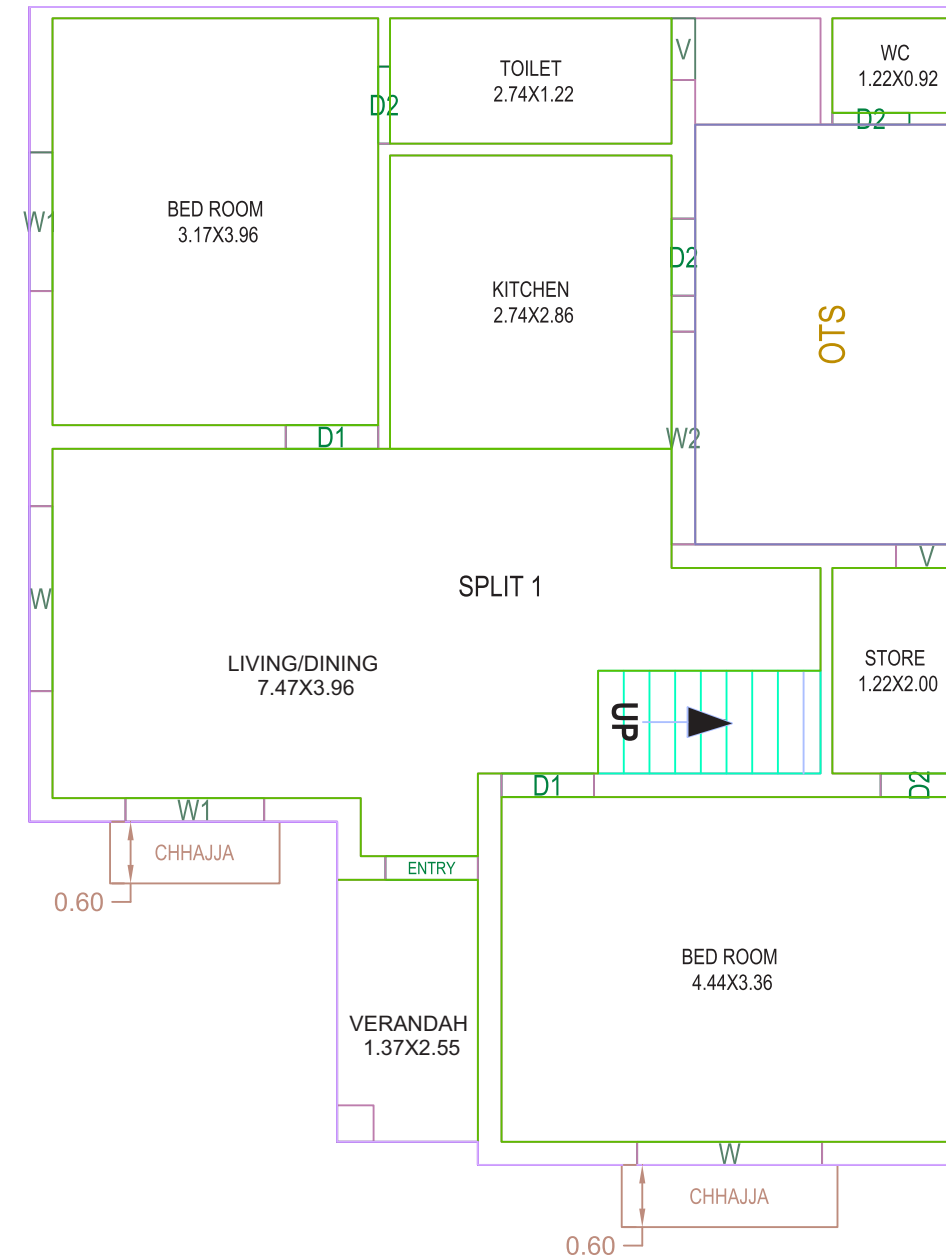

GROUND FLOOR PLAN

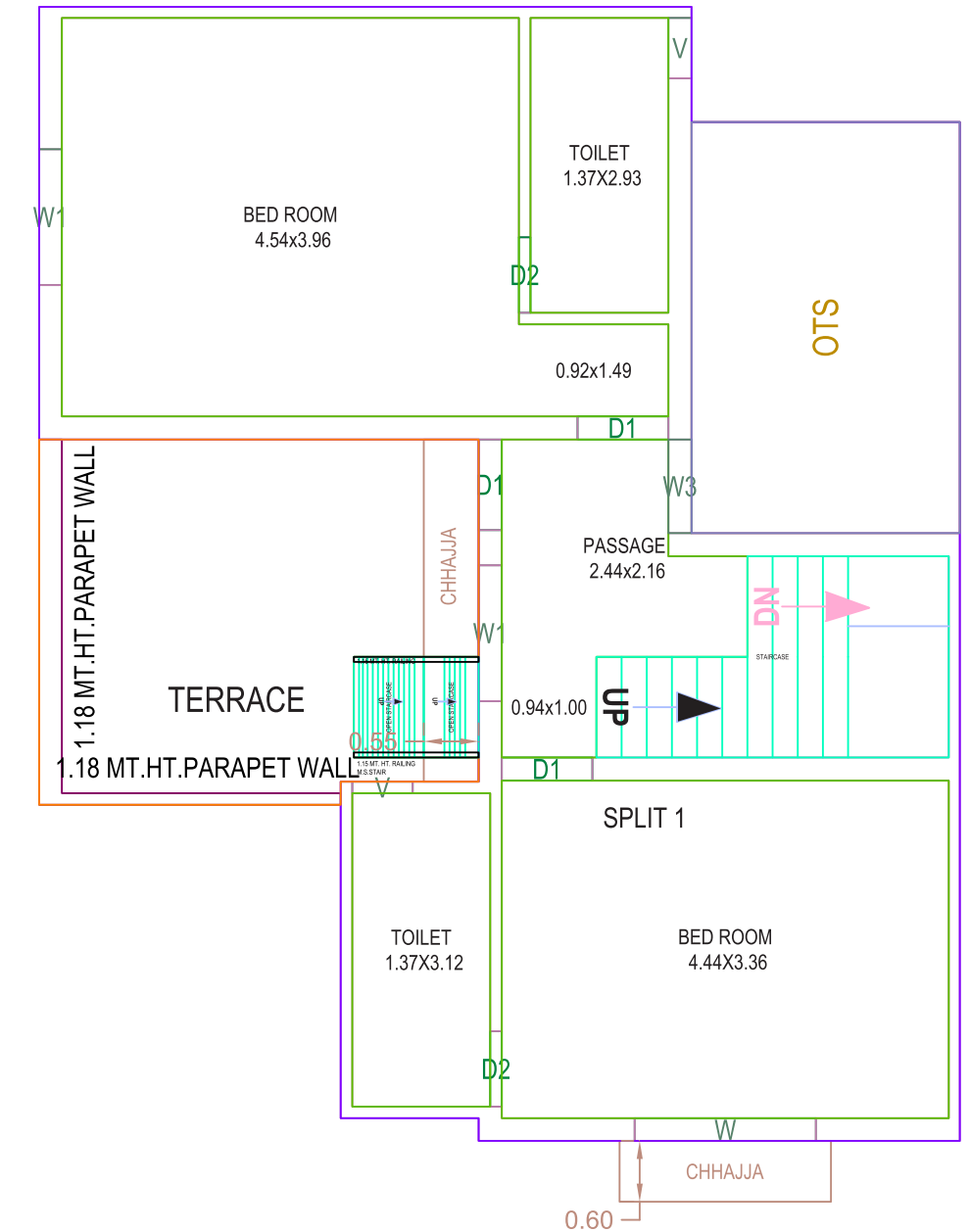

FIRST FLOOR PLAN

**UNIT PLAN
TYPE 16 (B-6,C-6,D-6)**

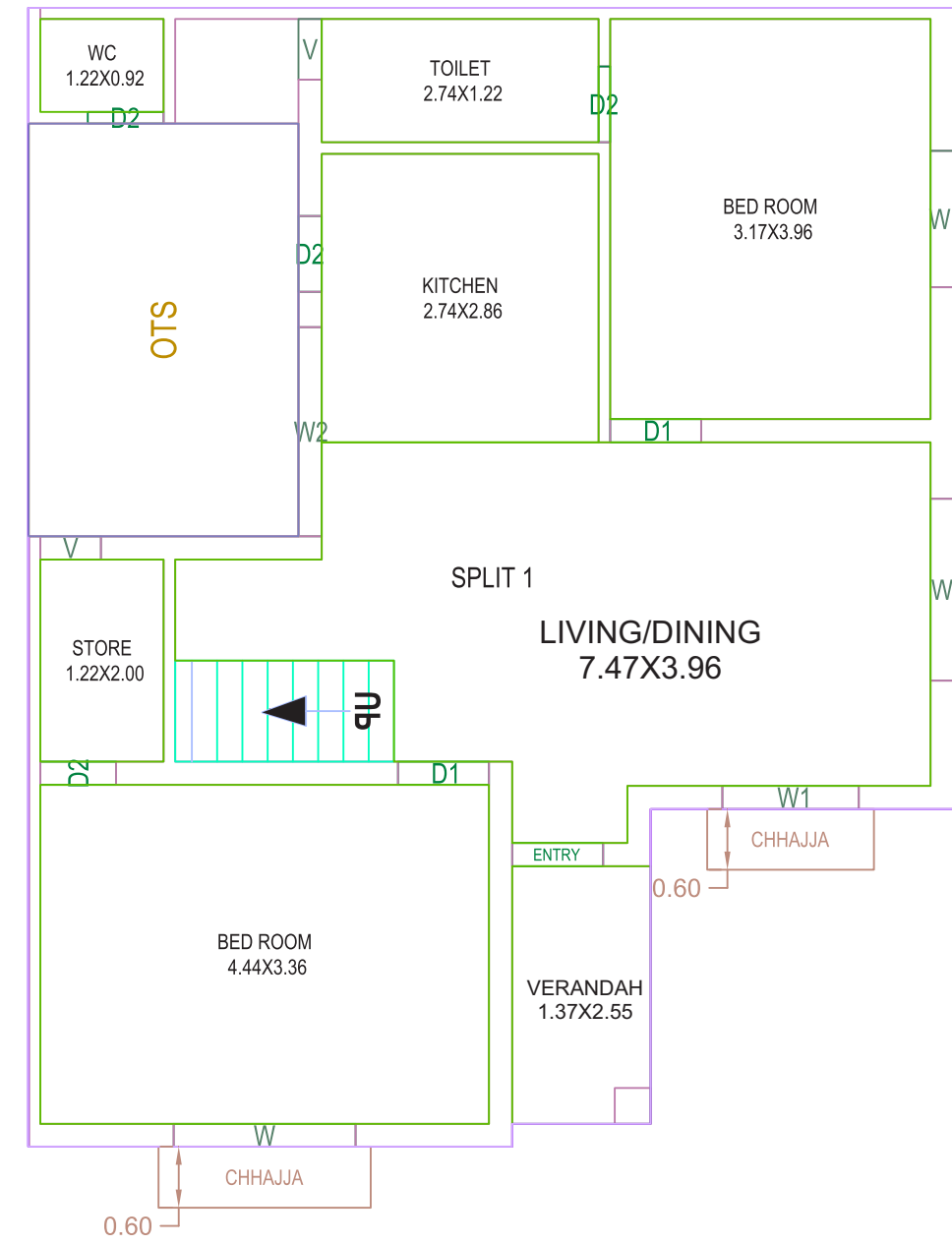

GROUND FLOOR PLAN

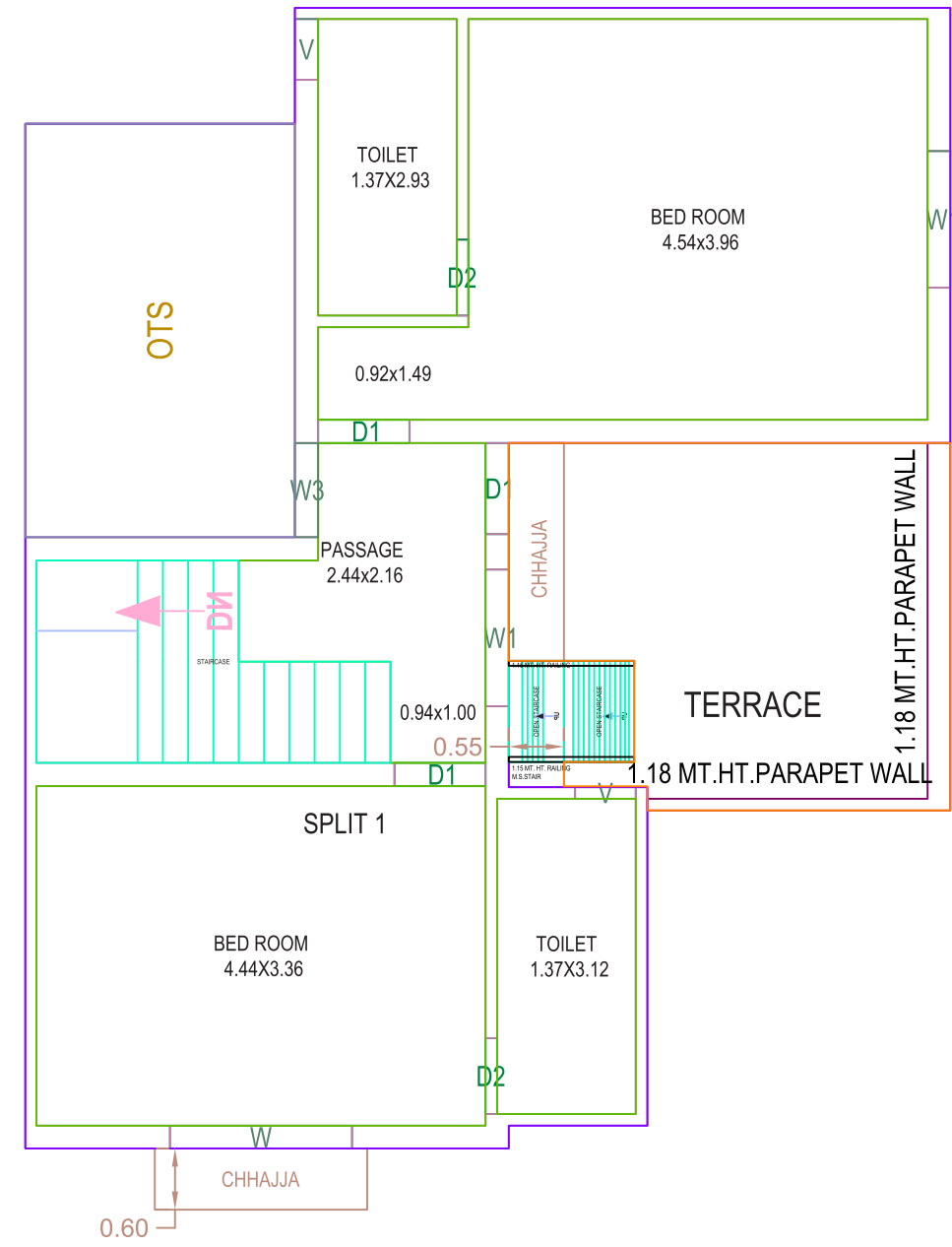

FIRST FLOOR PLAN

**UNIT PLAN
TYPE 17 (B-5)**

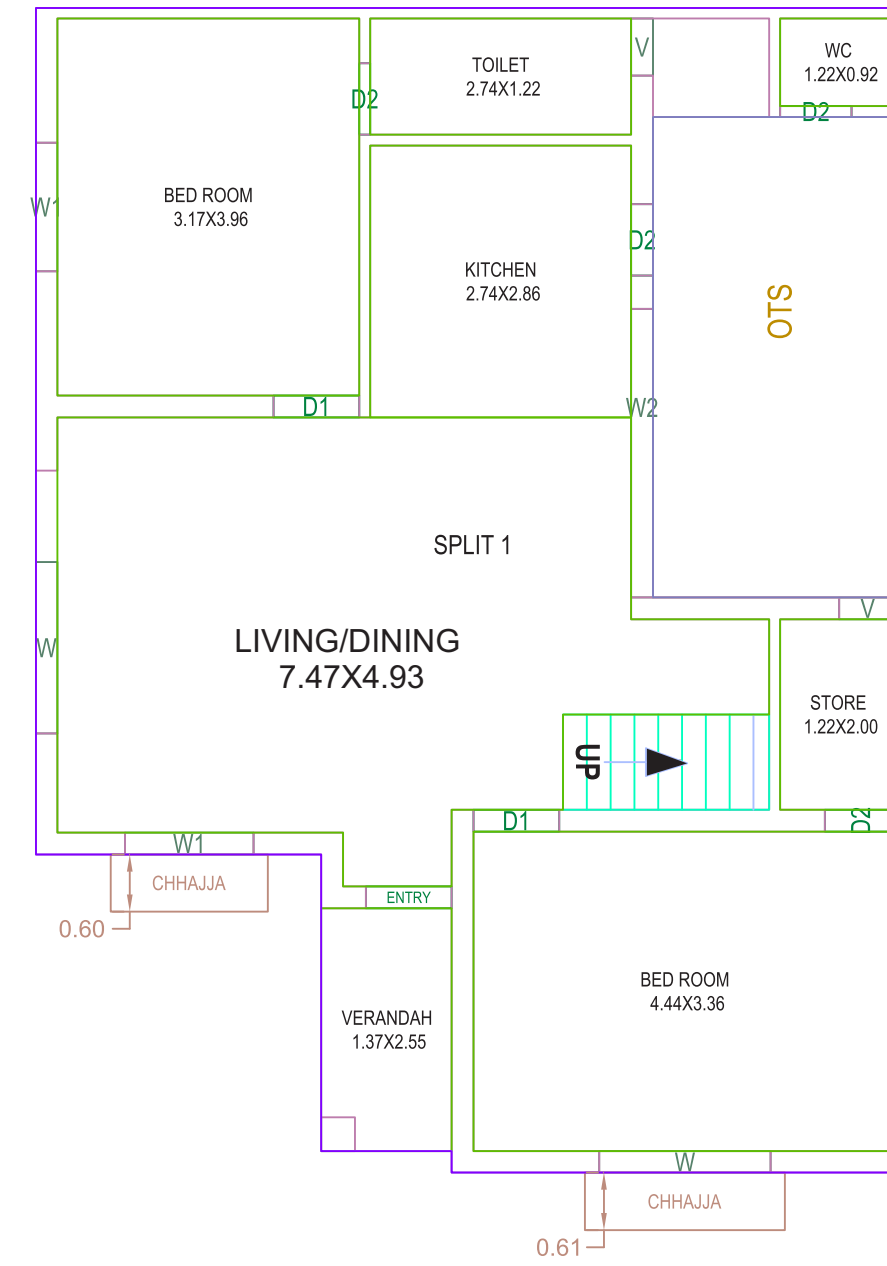

GROUND FLOOR PLAN

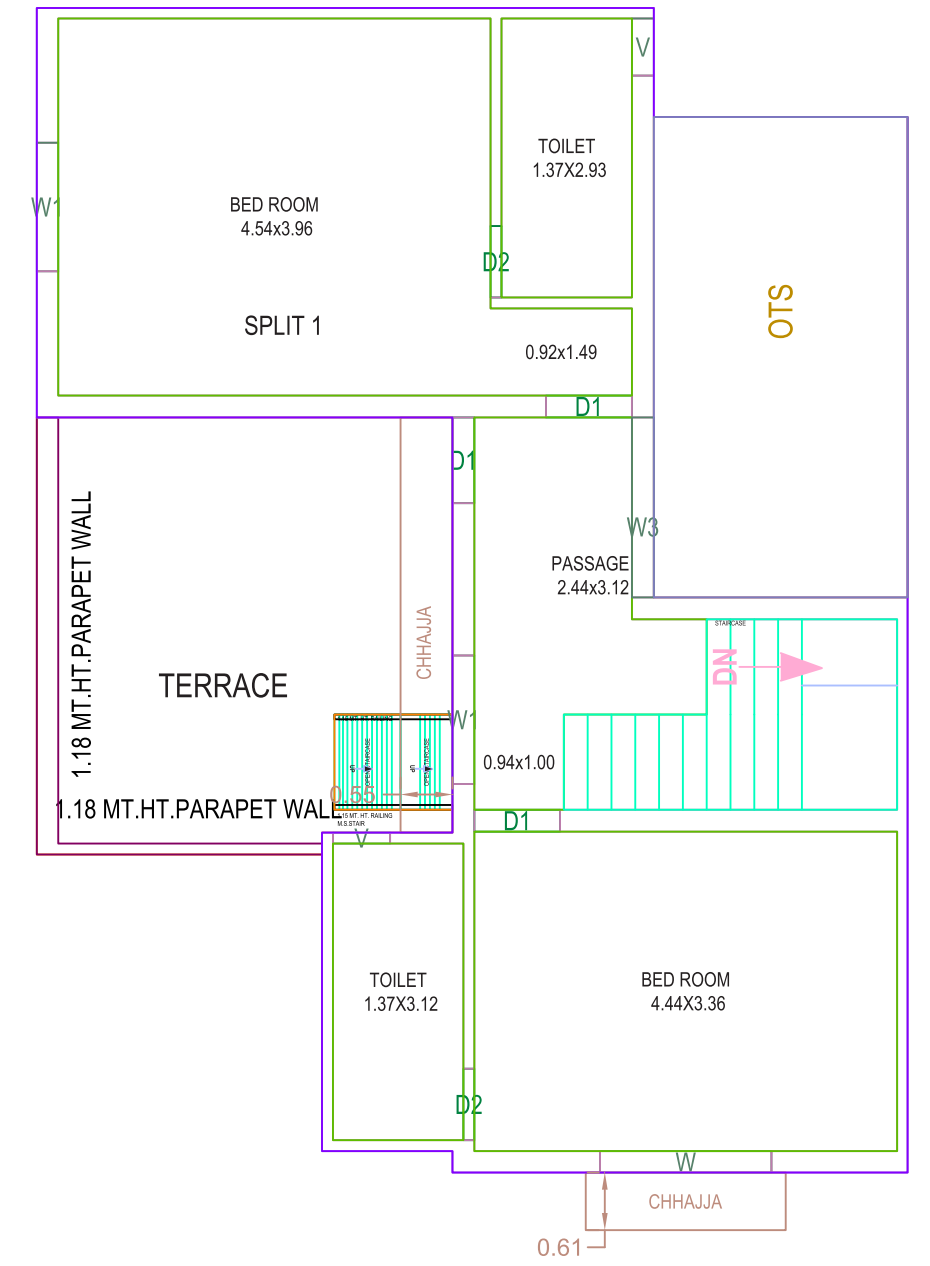

FIRST FLOOR PLAN

**UNIT PLAN
TYPE 18 (E-3,F-3)**

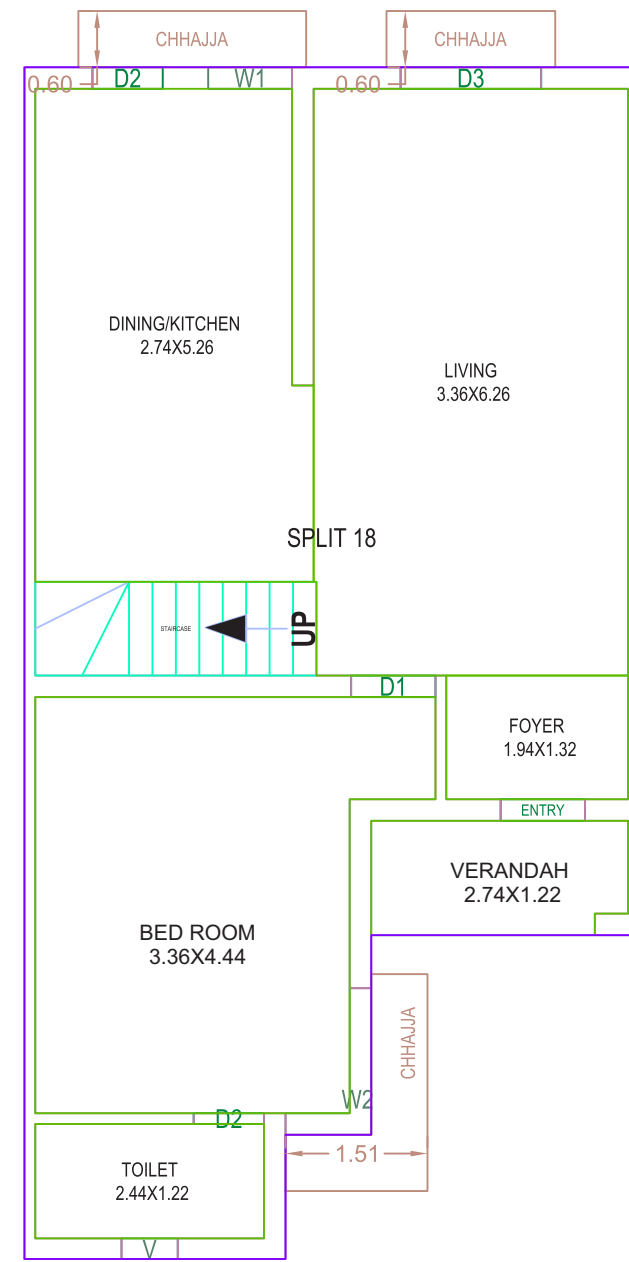

GROUND FLOOR PLAN

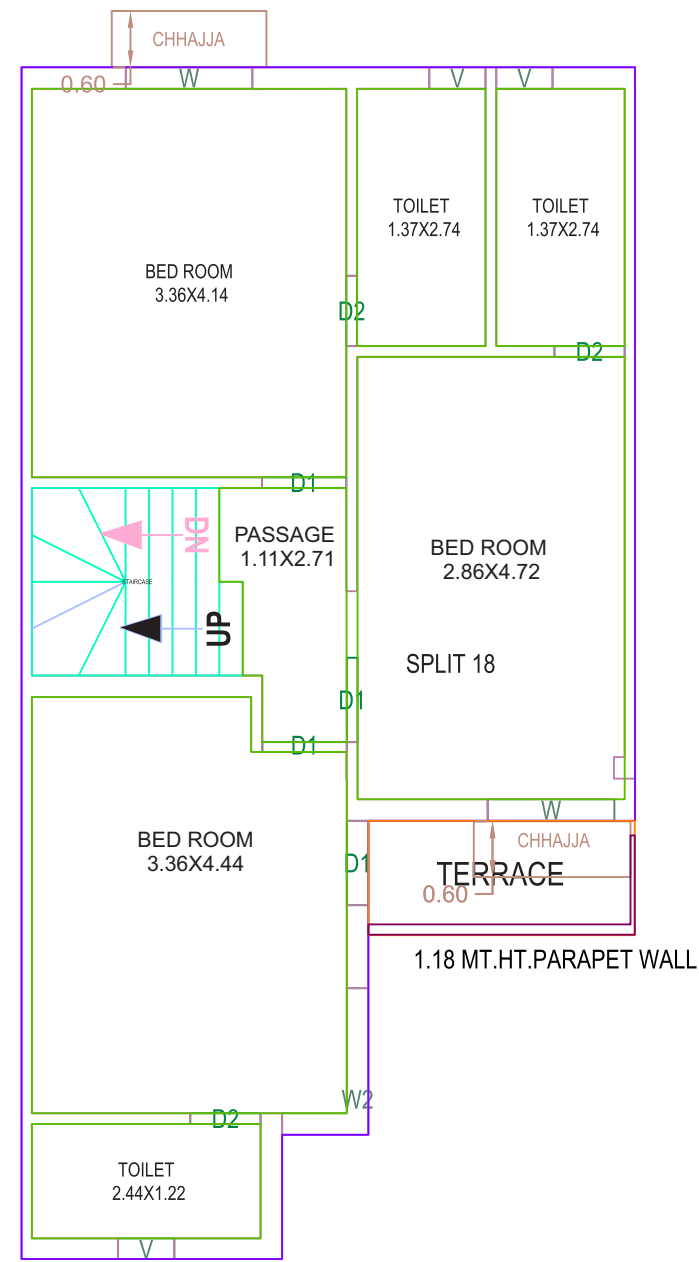

FIRST FLOOR PLAN

**UNIT PLAN
TYPE 19 (E-4,F-2,F-4)**

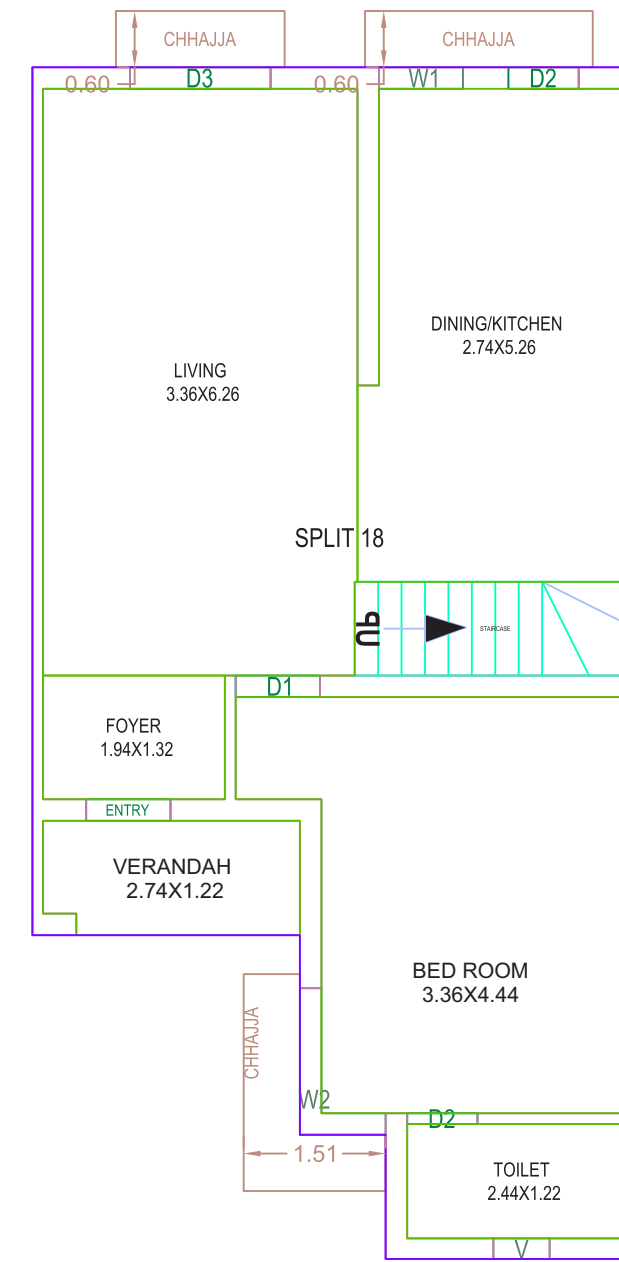

GROUND FLOOR PLAN

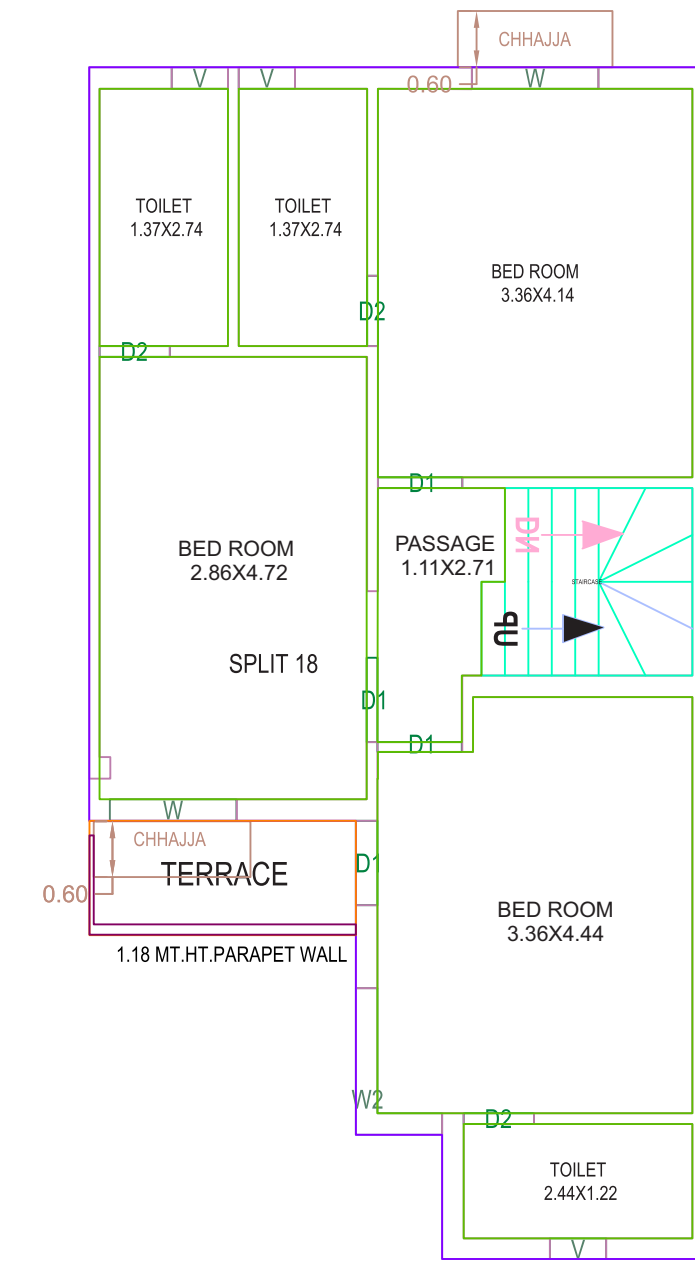

FIRST FLOOR PLAN

UNIT PLAN TYPE 20 (F-5)

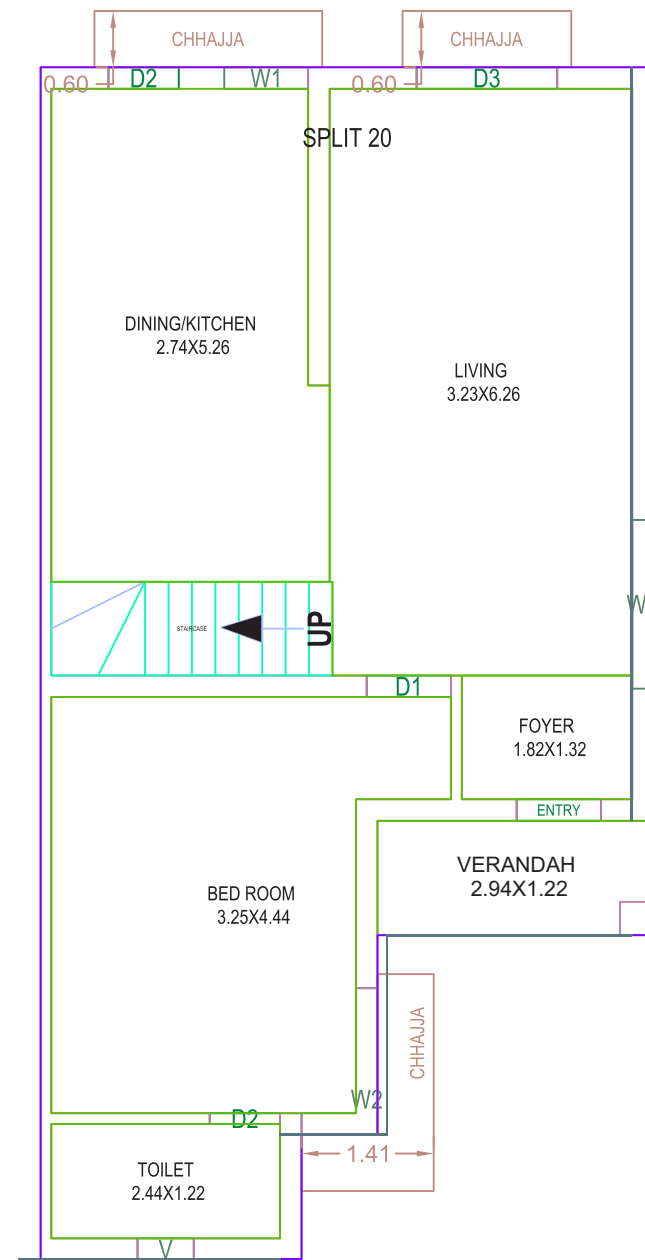

GROUND FLOOR PLAN

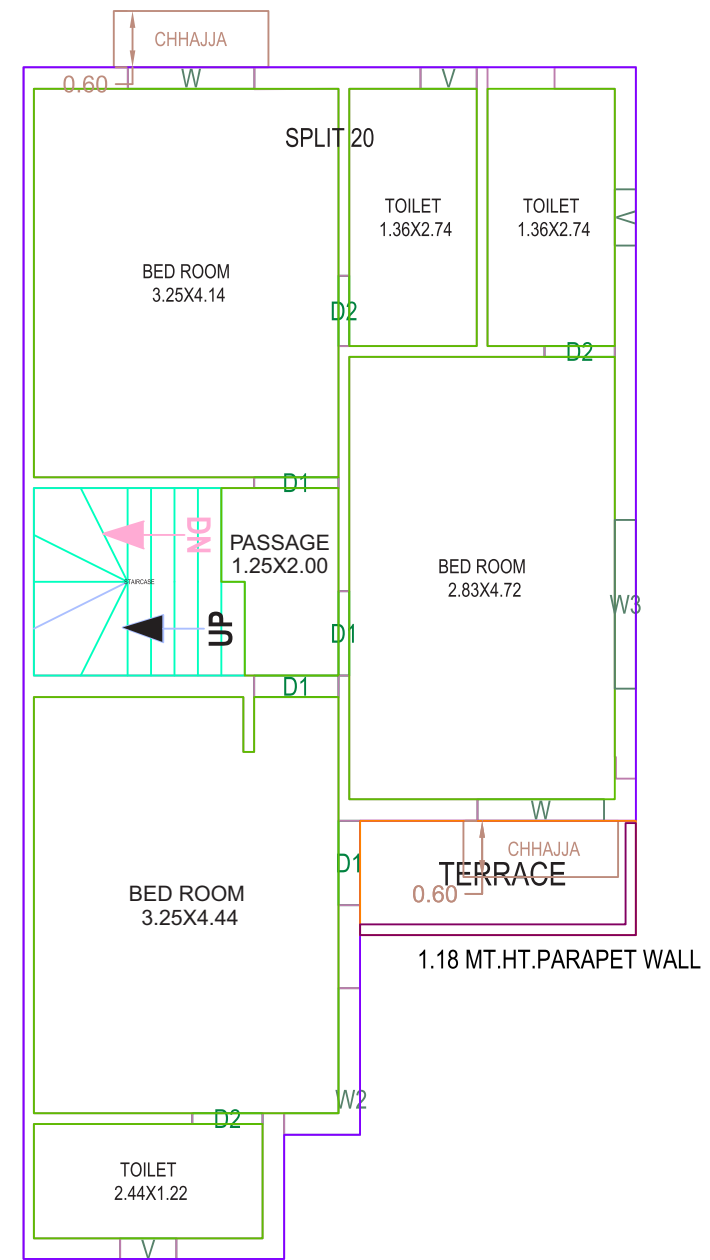

FIRST FLOOR PLAN

UNIT PLAN TYPE 21 (F-1)

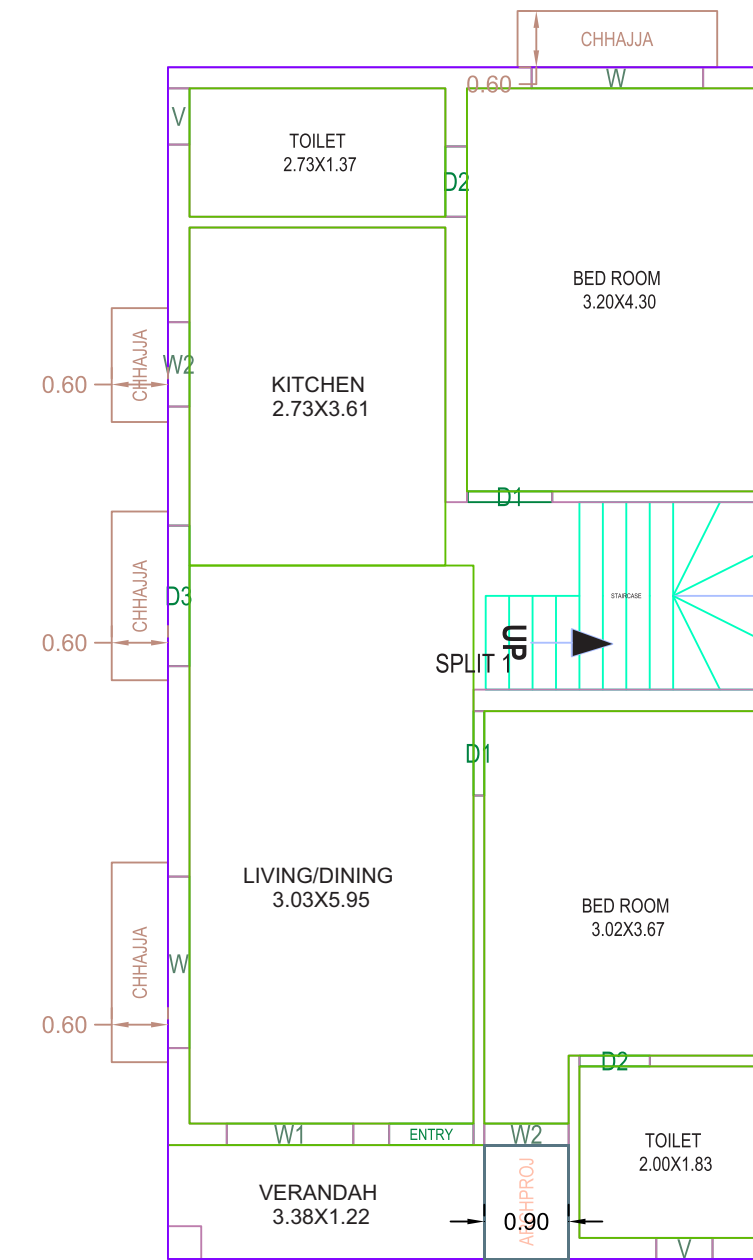

GROUND FLOOR PLAN

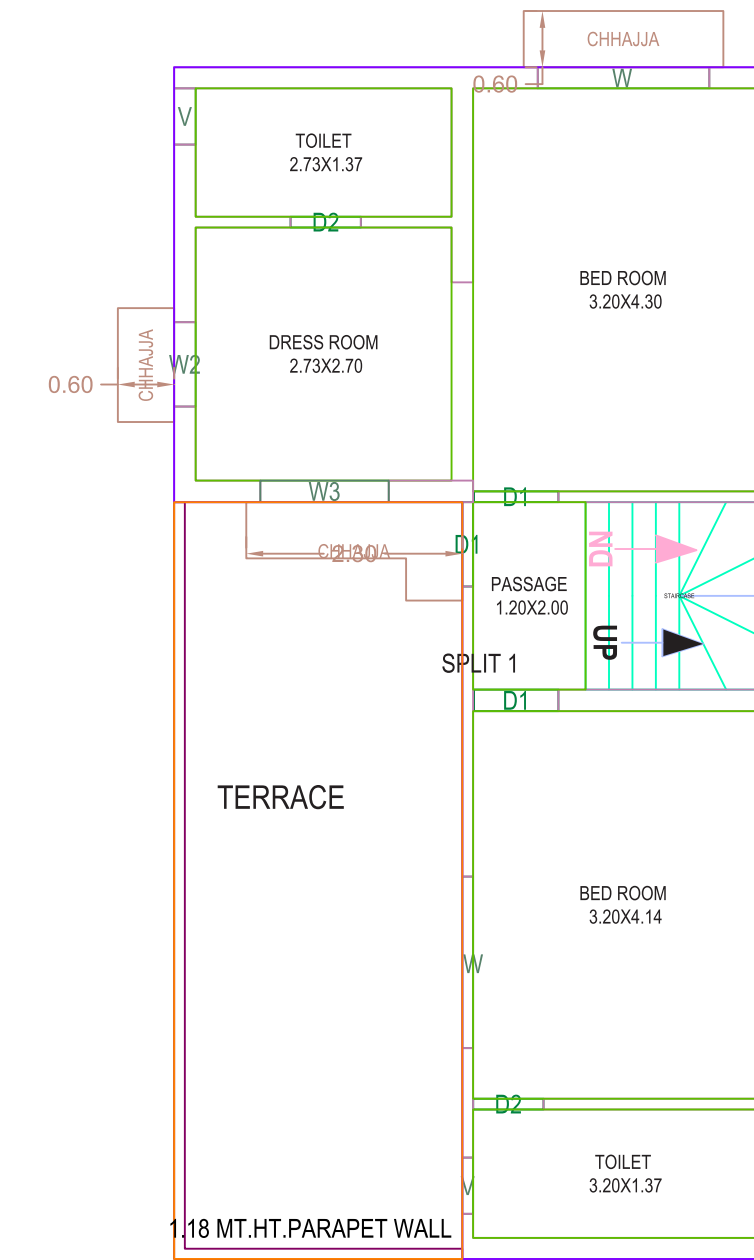

FIRST FLOOR PLAN

**UNIT PLAN
TYPE 22 (E-2)**

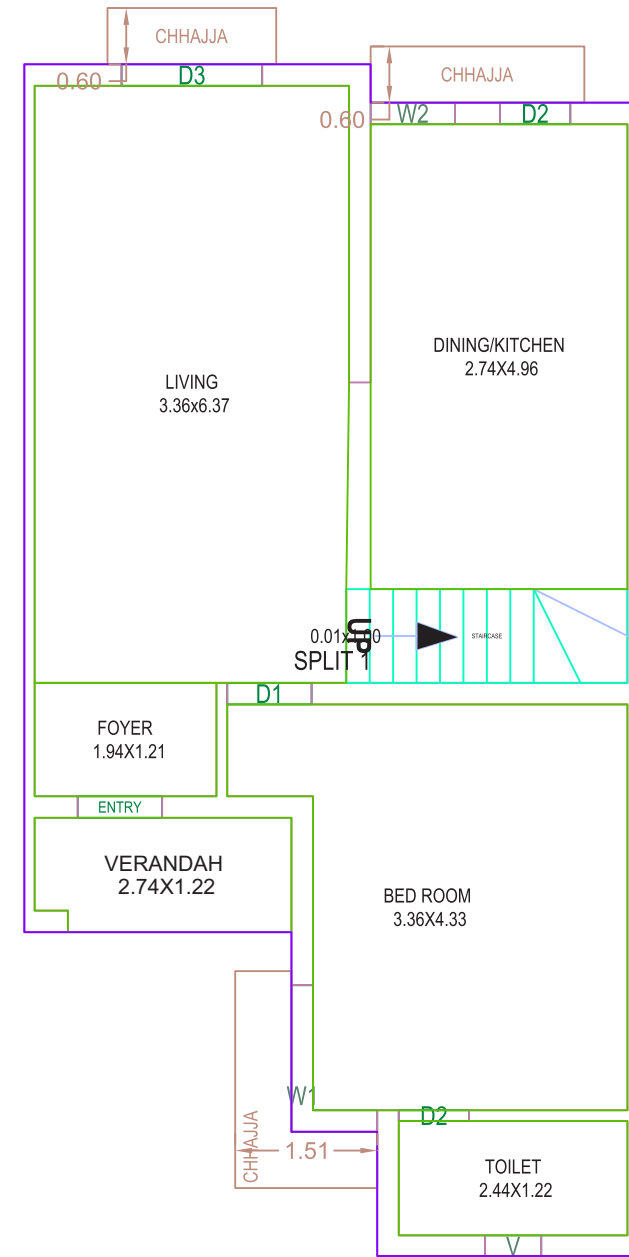

GROUND FLOOR PLAN

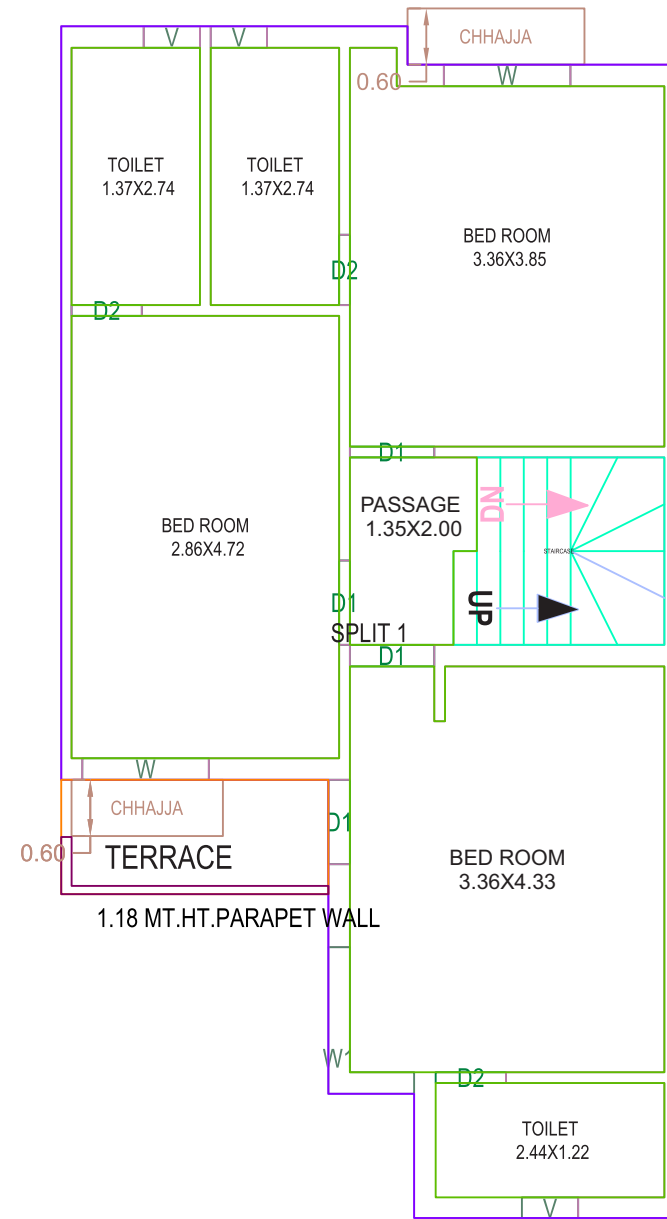

FIRST FLOOR PLAN

**UNIT PLAN
TYPE 23 (E-5)**

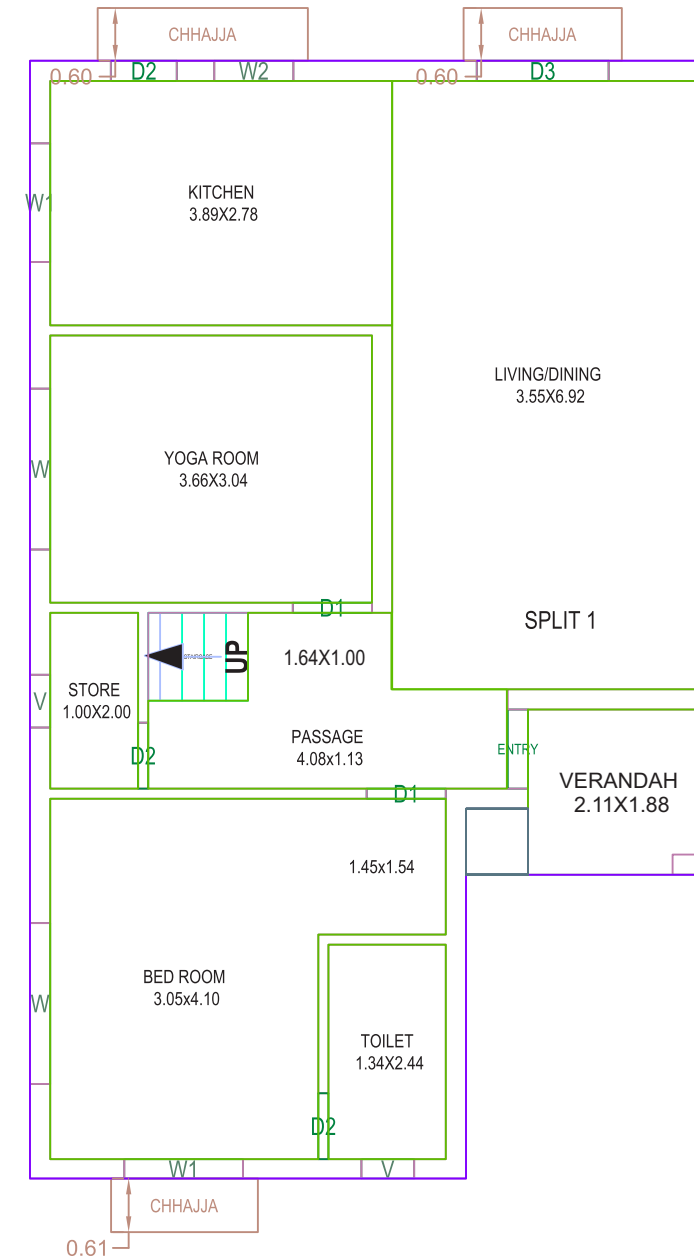

GROUND FLOOR PLAN

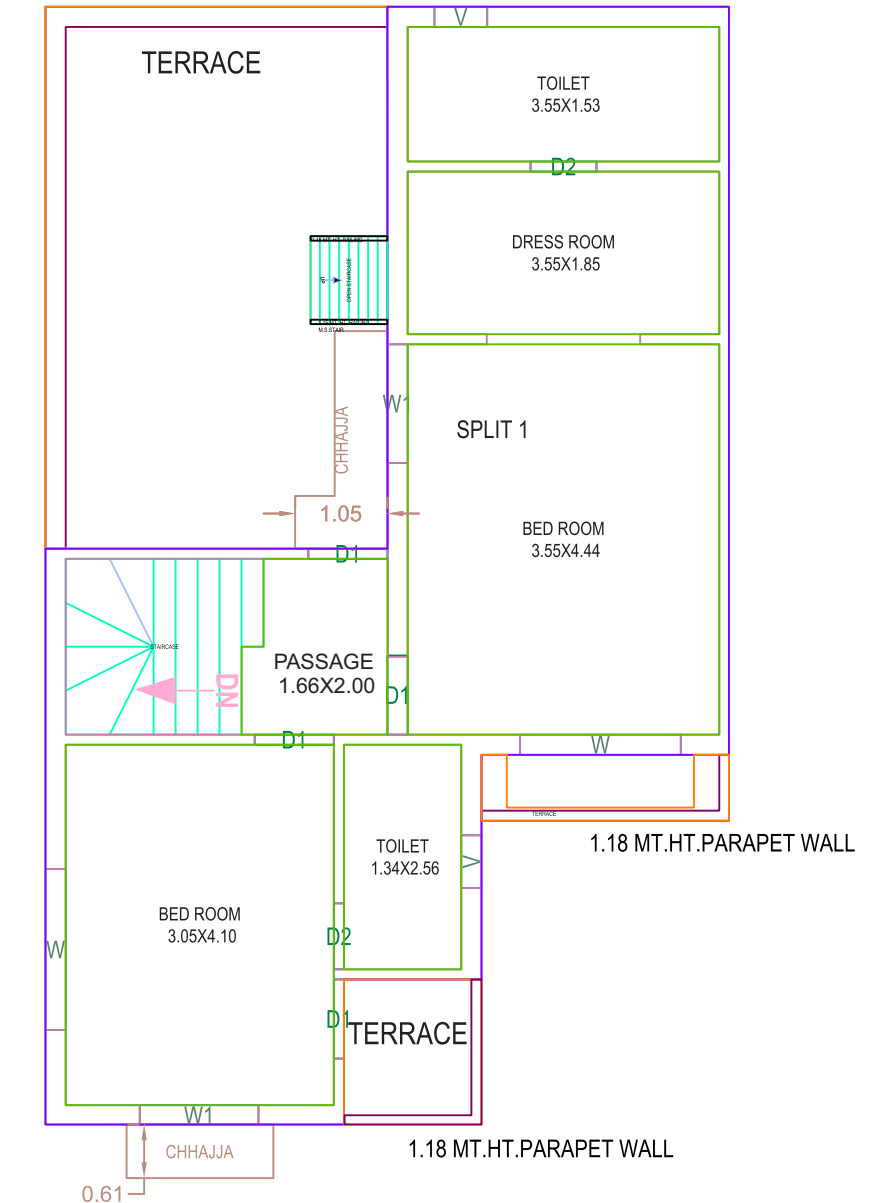

FIRST FLOOR PLAN

UNIT PLAN TYPE 24 (E-1)

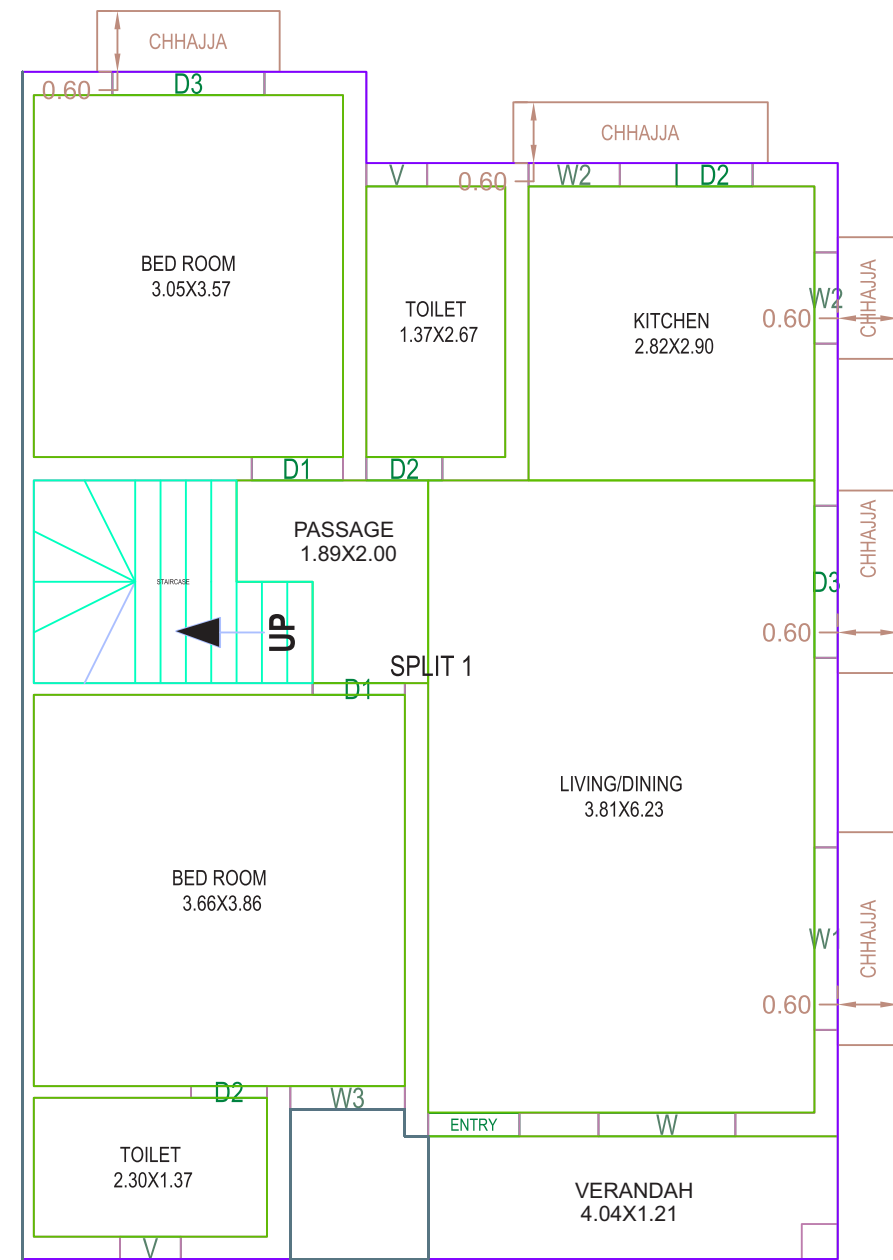

GROUND FLOOR PLAN

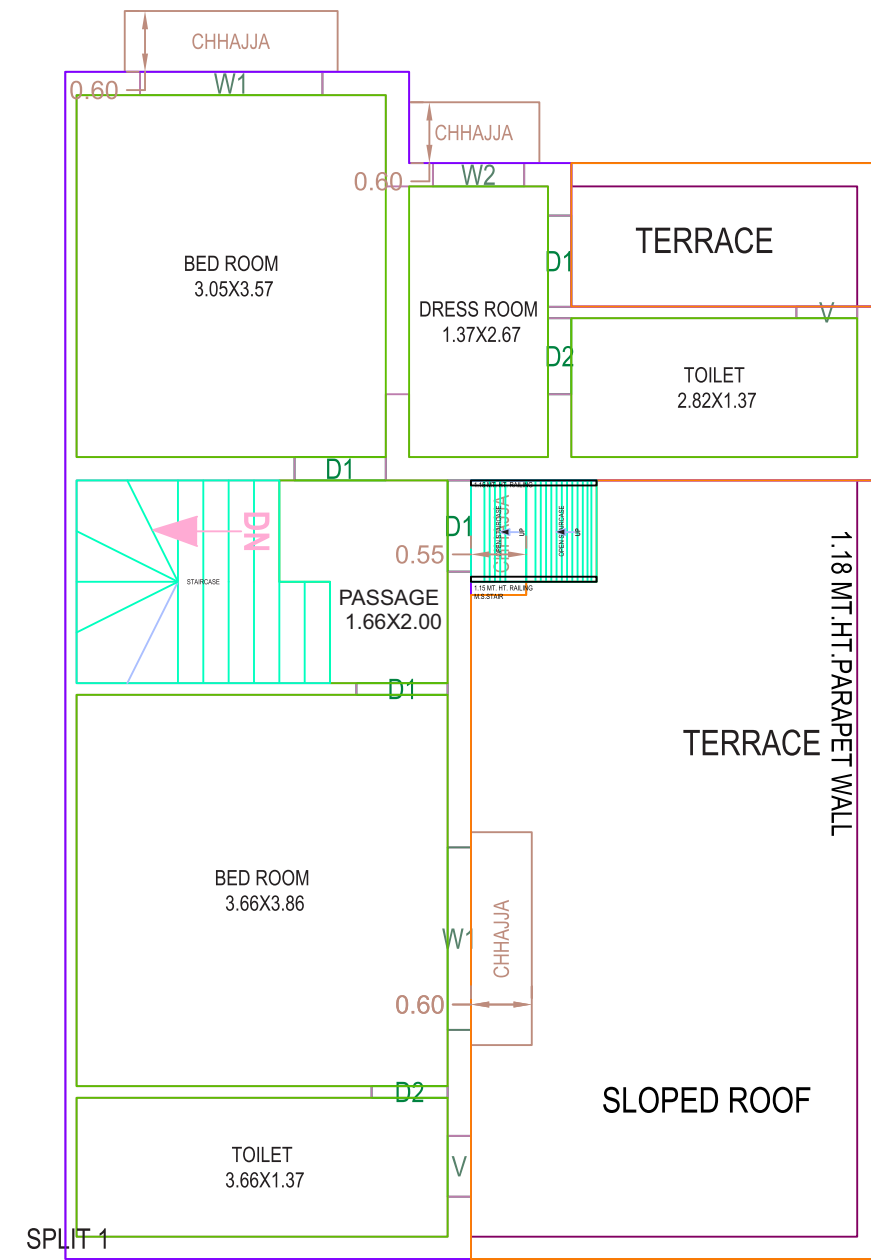

FIRST FLOOR PLAN

UNIT PLAN TYPE 25 (A-8)

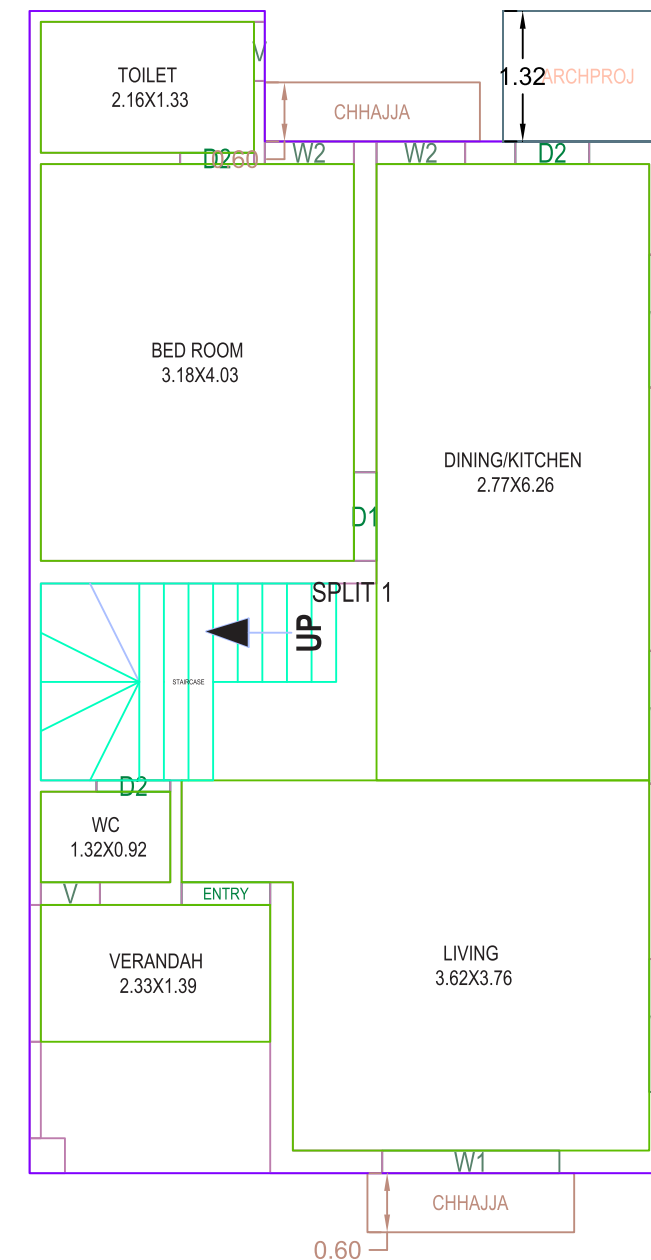

GROUND FLOOR PLAN

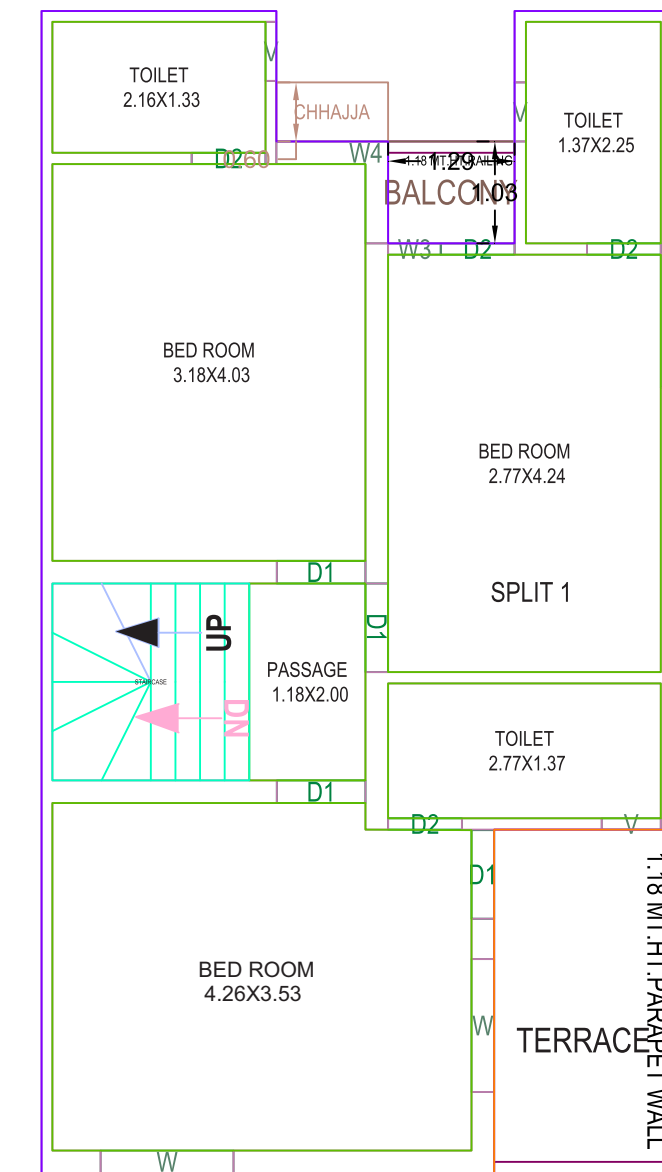

FIRST FLOOR PLAN

UNIT PLAN TYPE 26 (A-7)

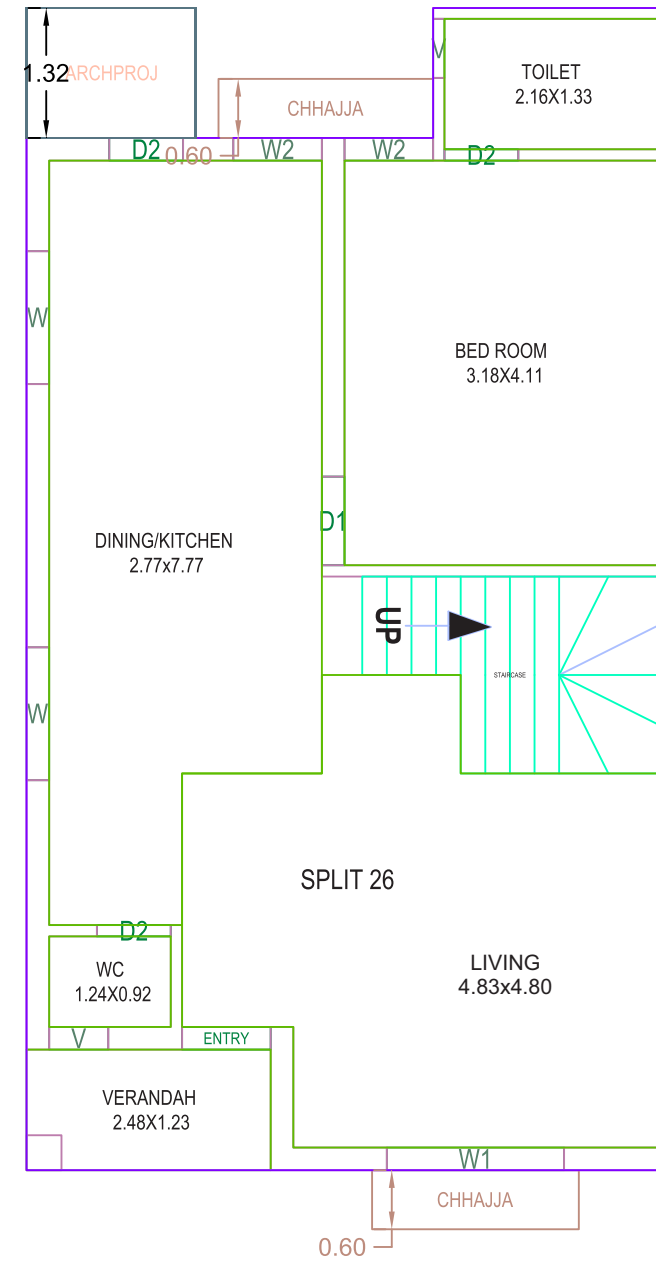

GROUND FLOOR PLAN

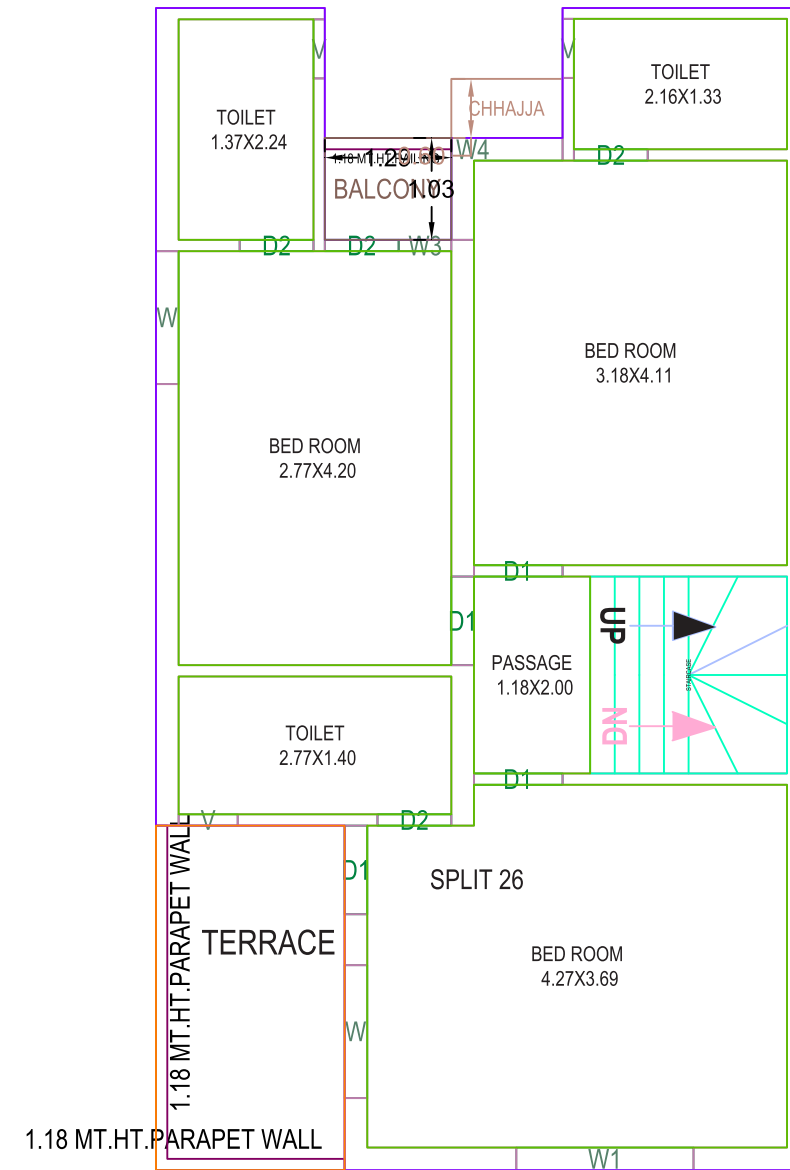

FIRST FLOOR PLAN

UNIT PLAN TYPE 27 (J-6)

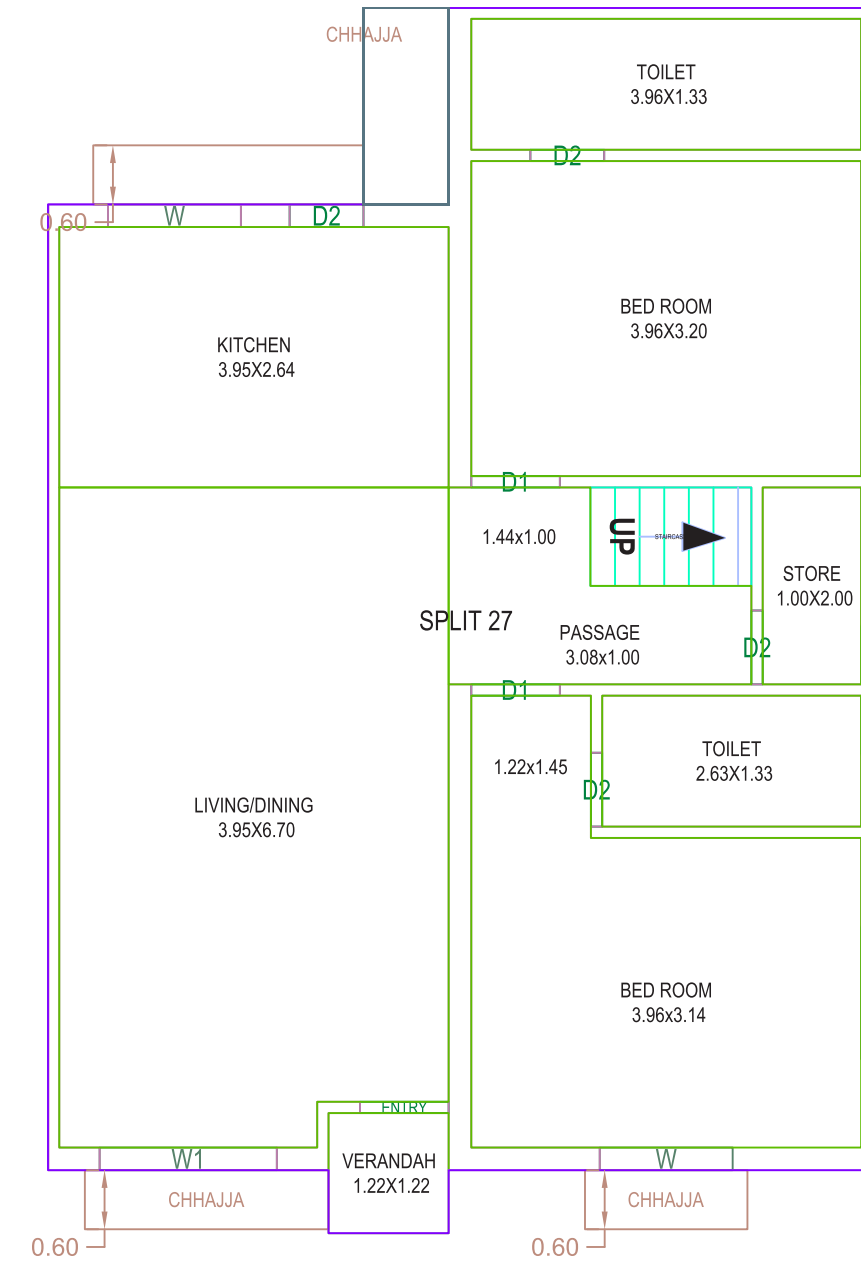

GROUND FLOOR PLAN

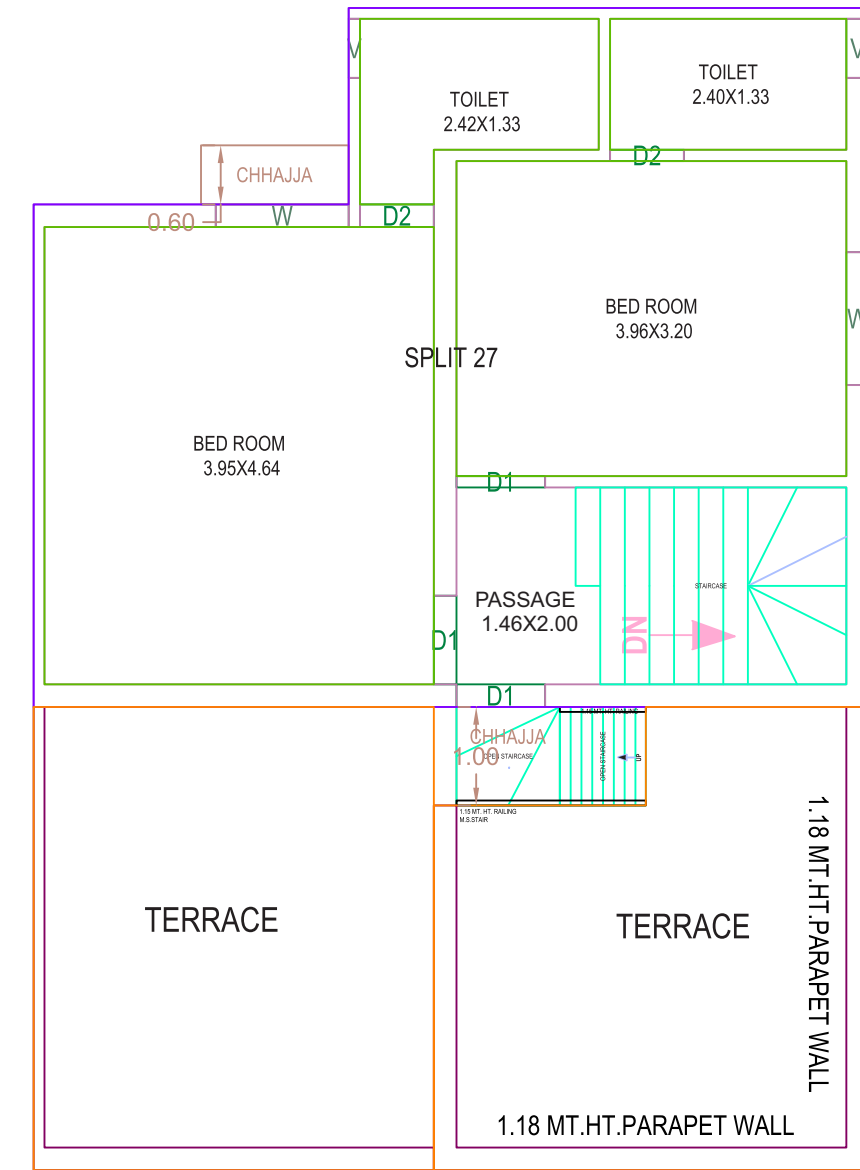

FIRST FLOOR PLAN

UNIT PLAN TYPE 28 (J-7)

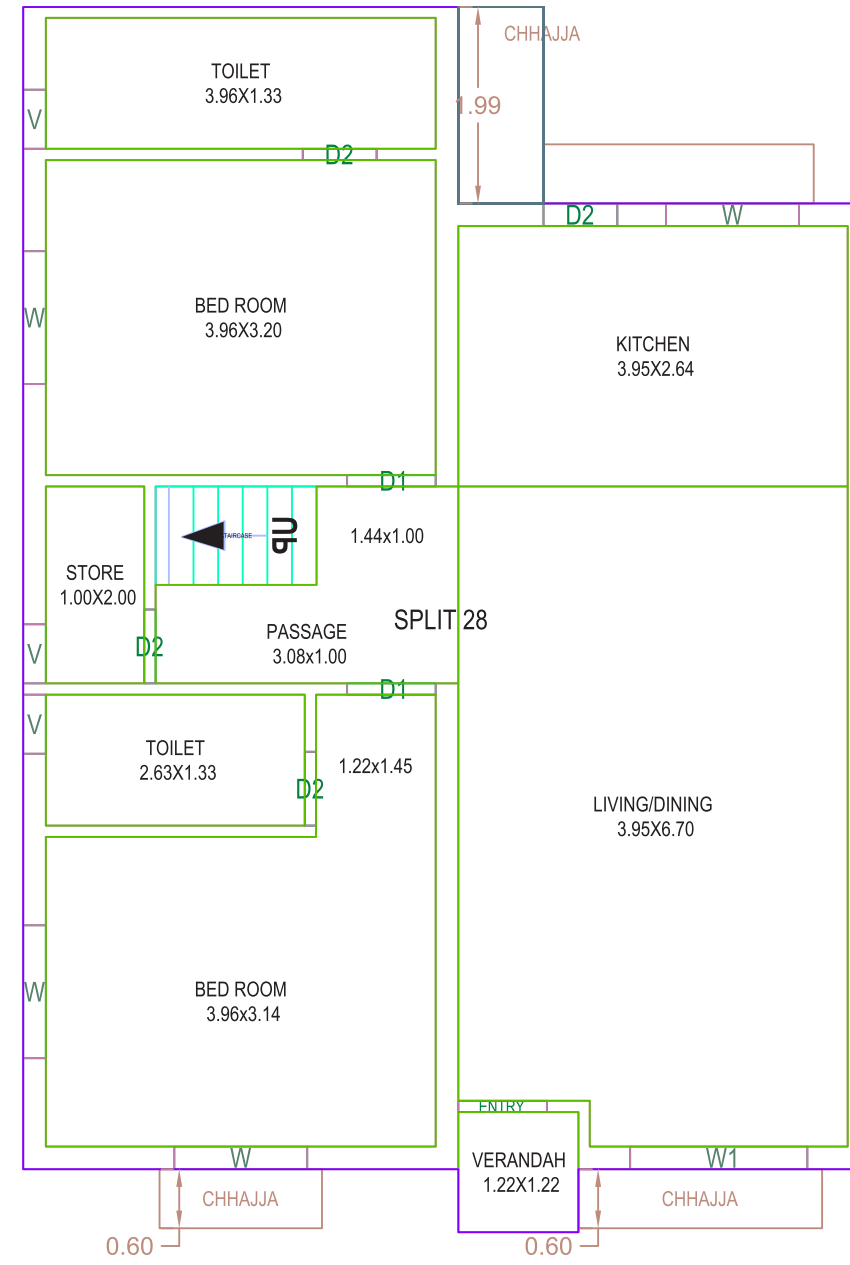

GROUND FLOOR PLAN

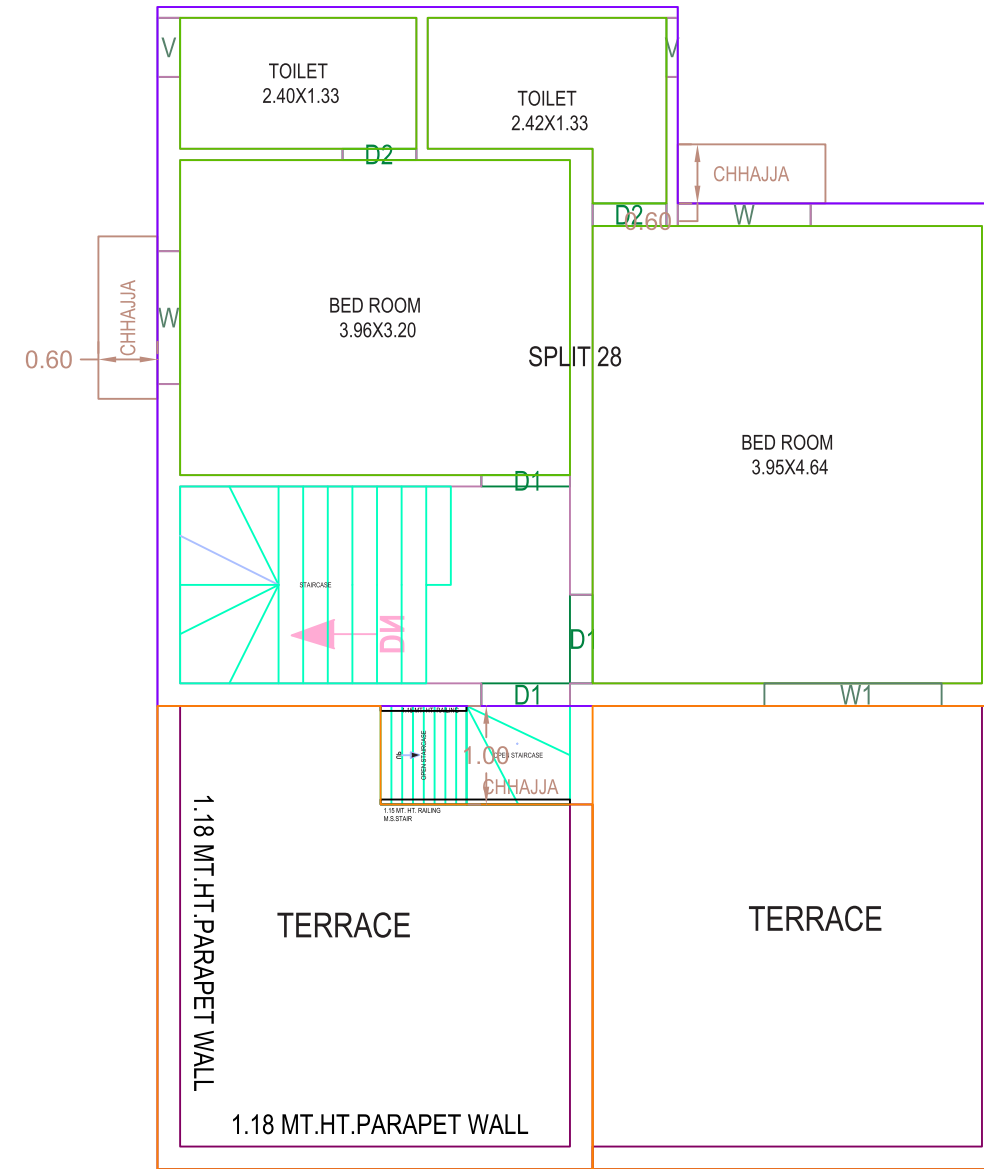

SLOPED ROOF

FIRST FLOOR PLAN

UNIT PLAN TYPE 29 (D-1)

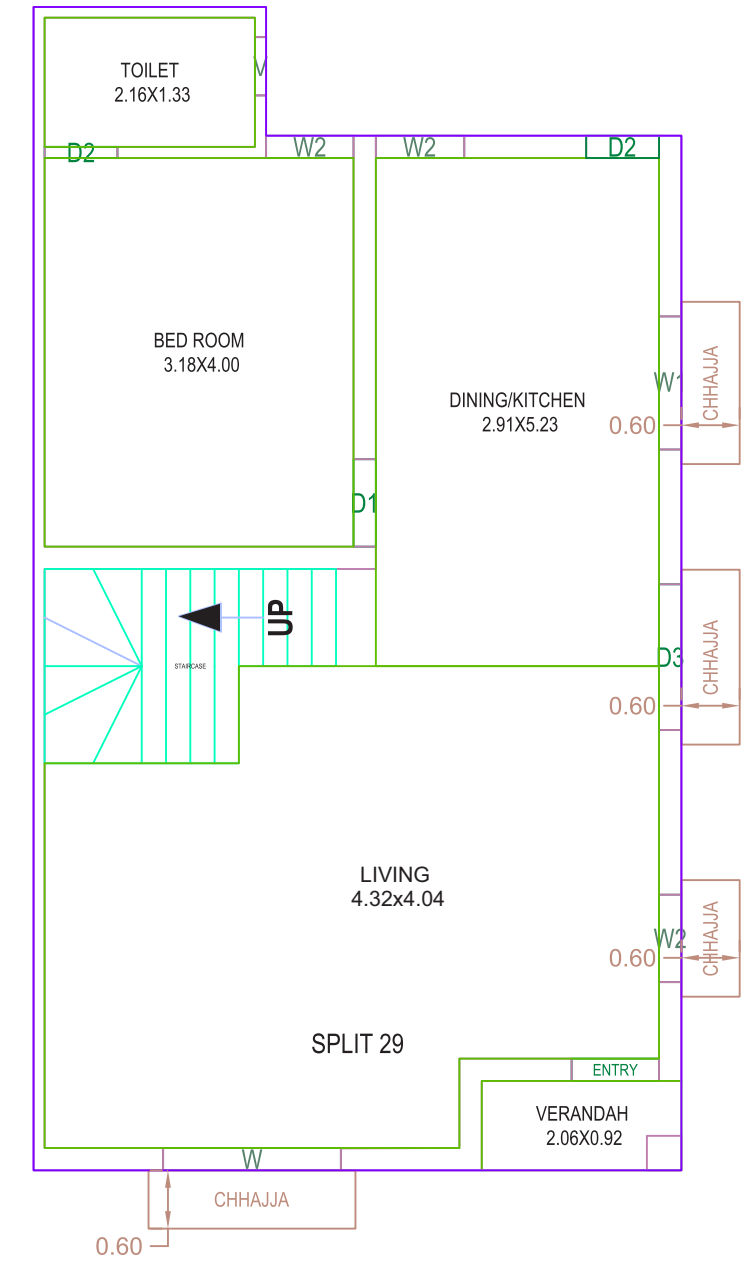

GROUND FLOOR PLAN

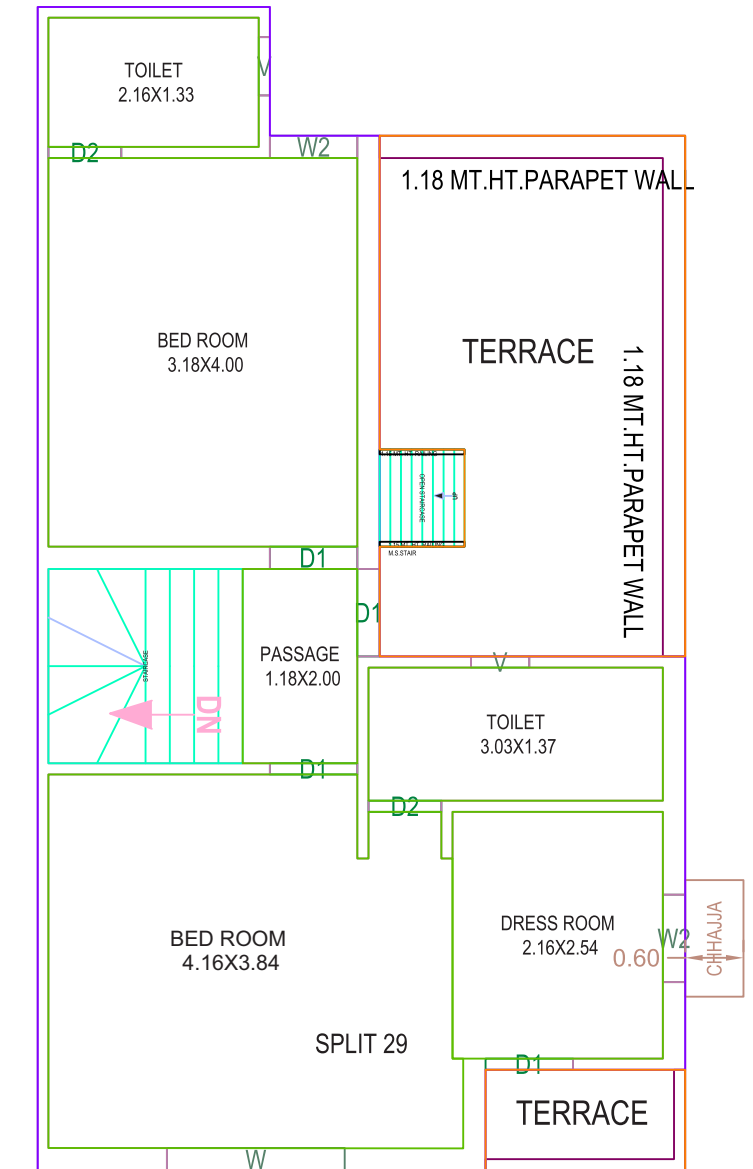

FIRST FLOOR PLAN

UNIT PLAN TYPE 30 (D-10)

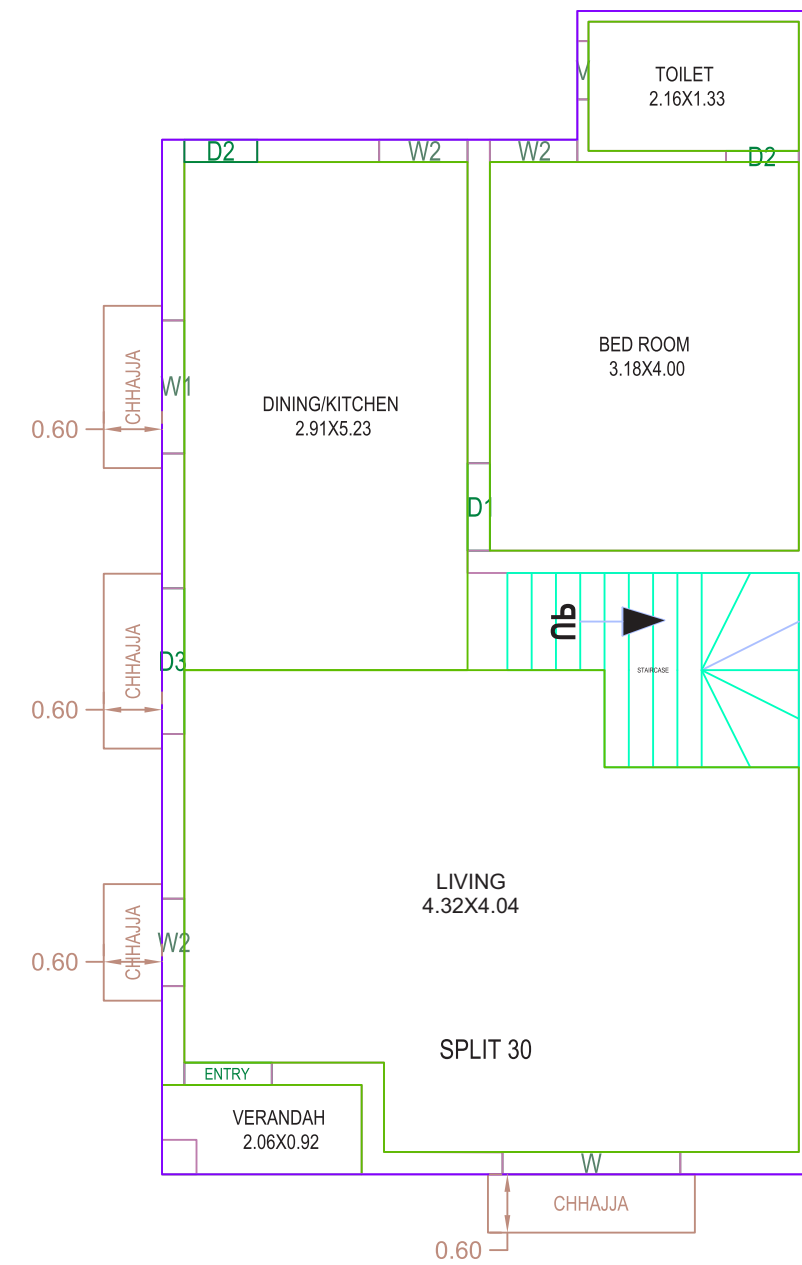

GROUND FLOOR PLAN

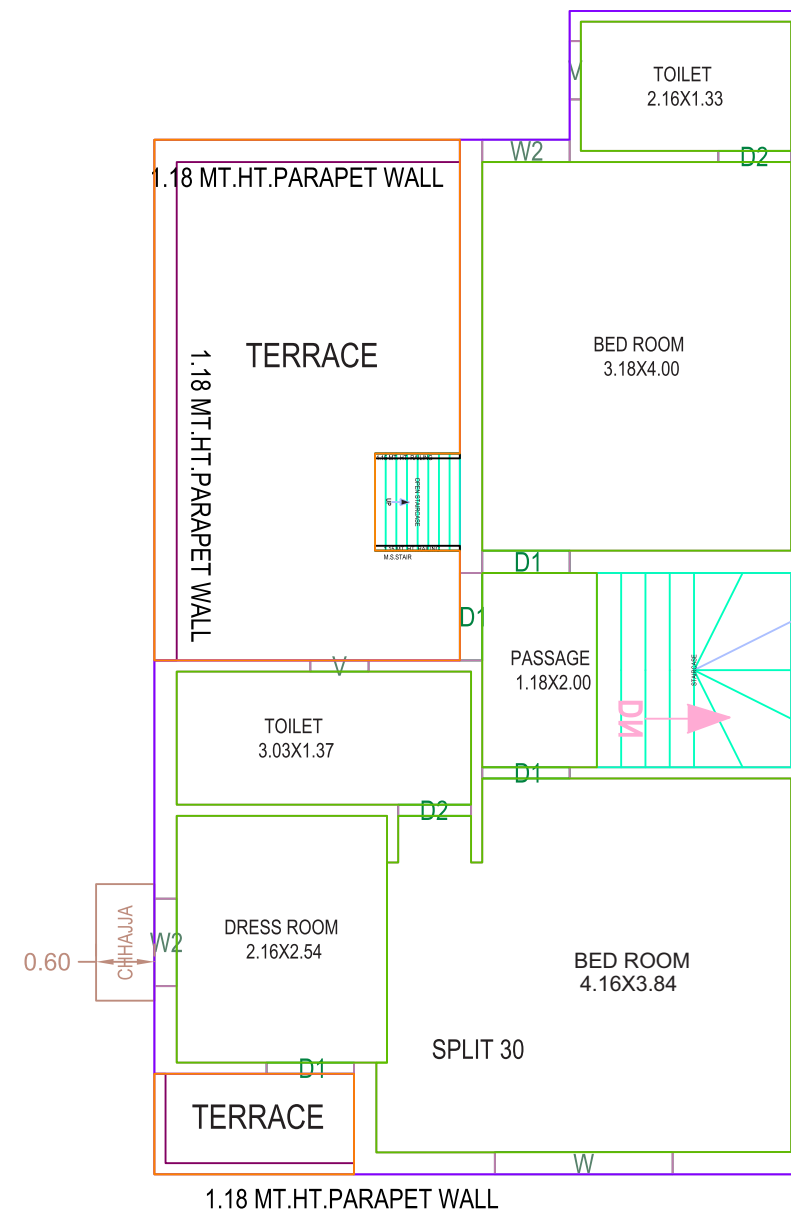

FIRST FLOOR PLAN

UNIT PLAN TYPE 31 (C-1,I-10)

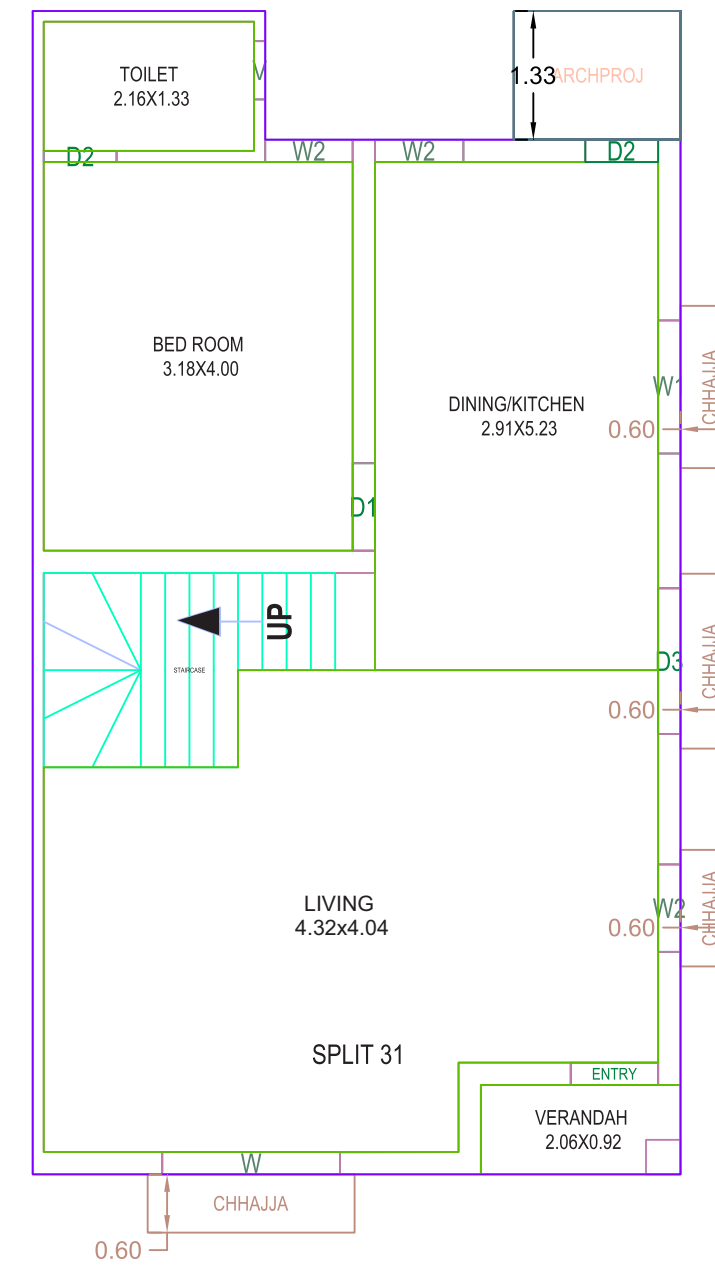

GROUND FLOOR PLAN

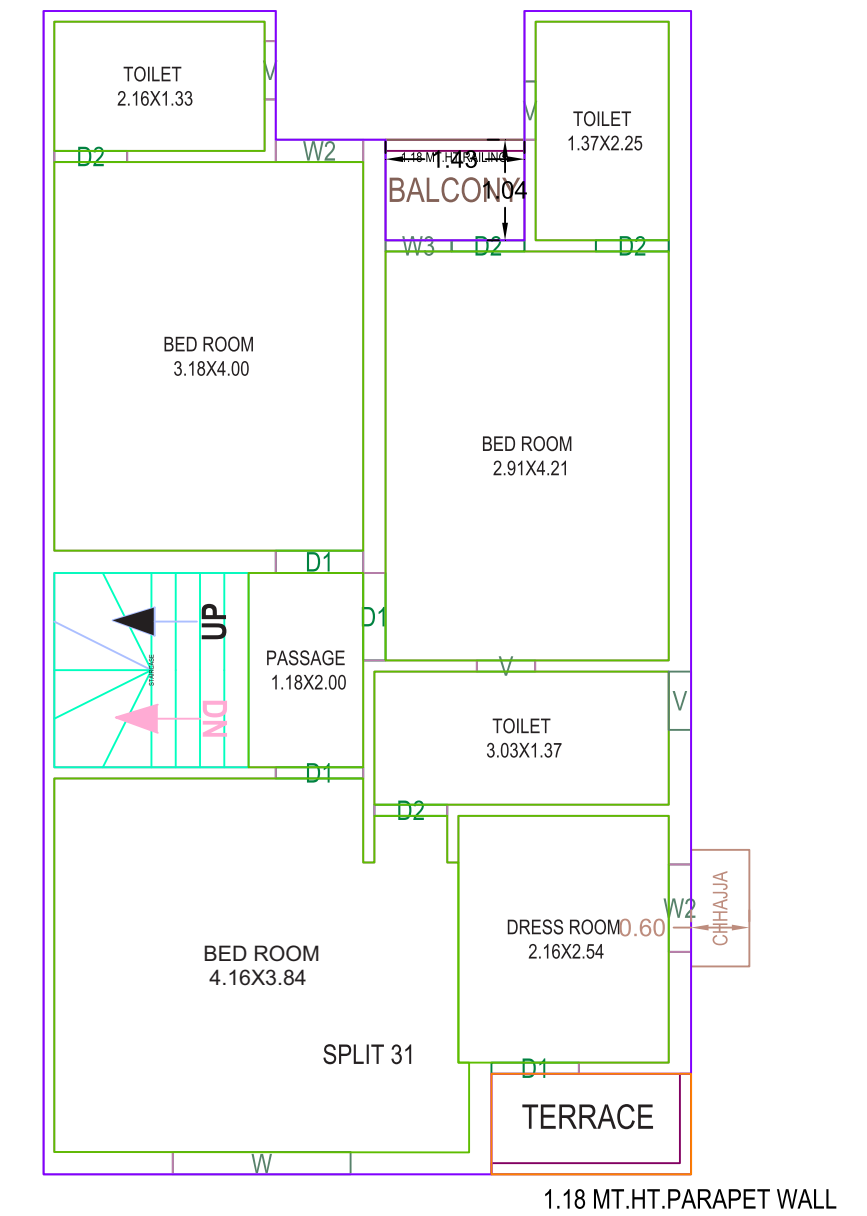

FIRST FLOOR PLAN

**UNIT PLAN
TYPE 32 (B-10,C-10,I-1)**

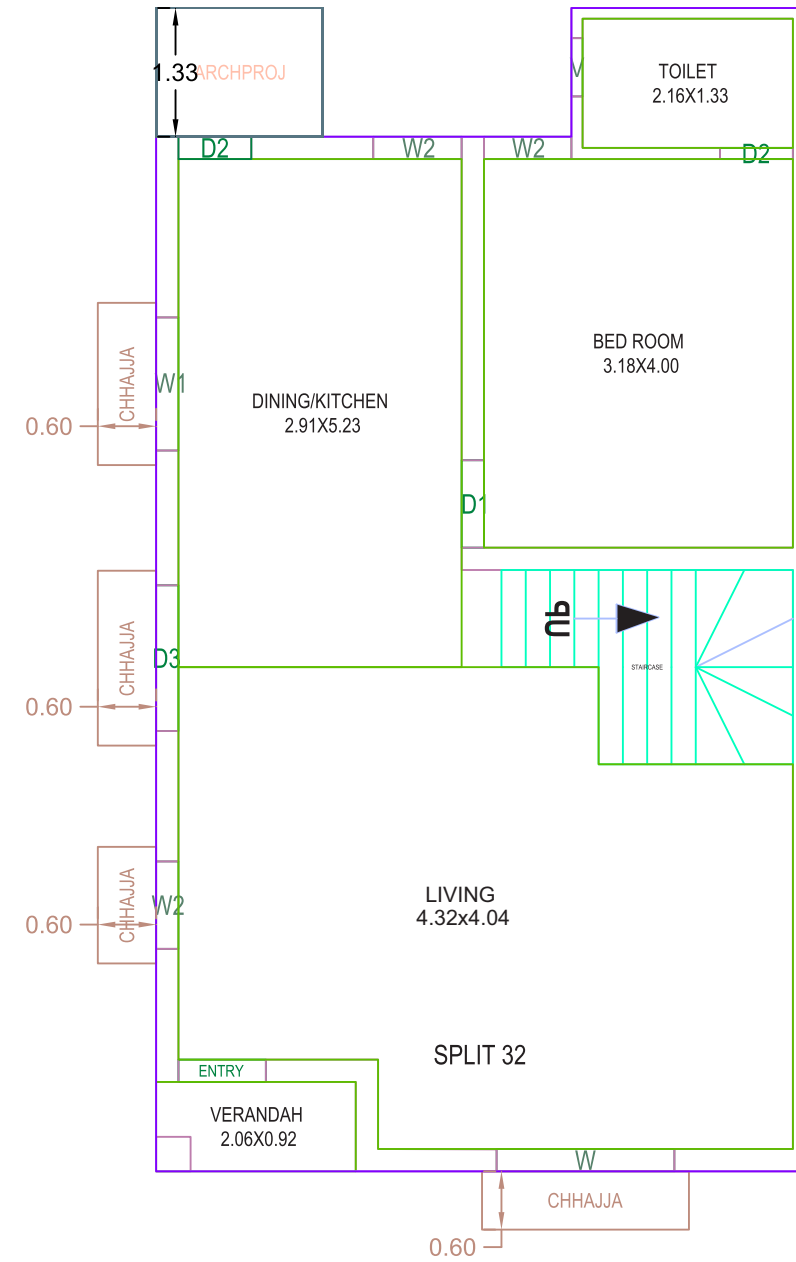

GROUND FLOOR PLAN

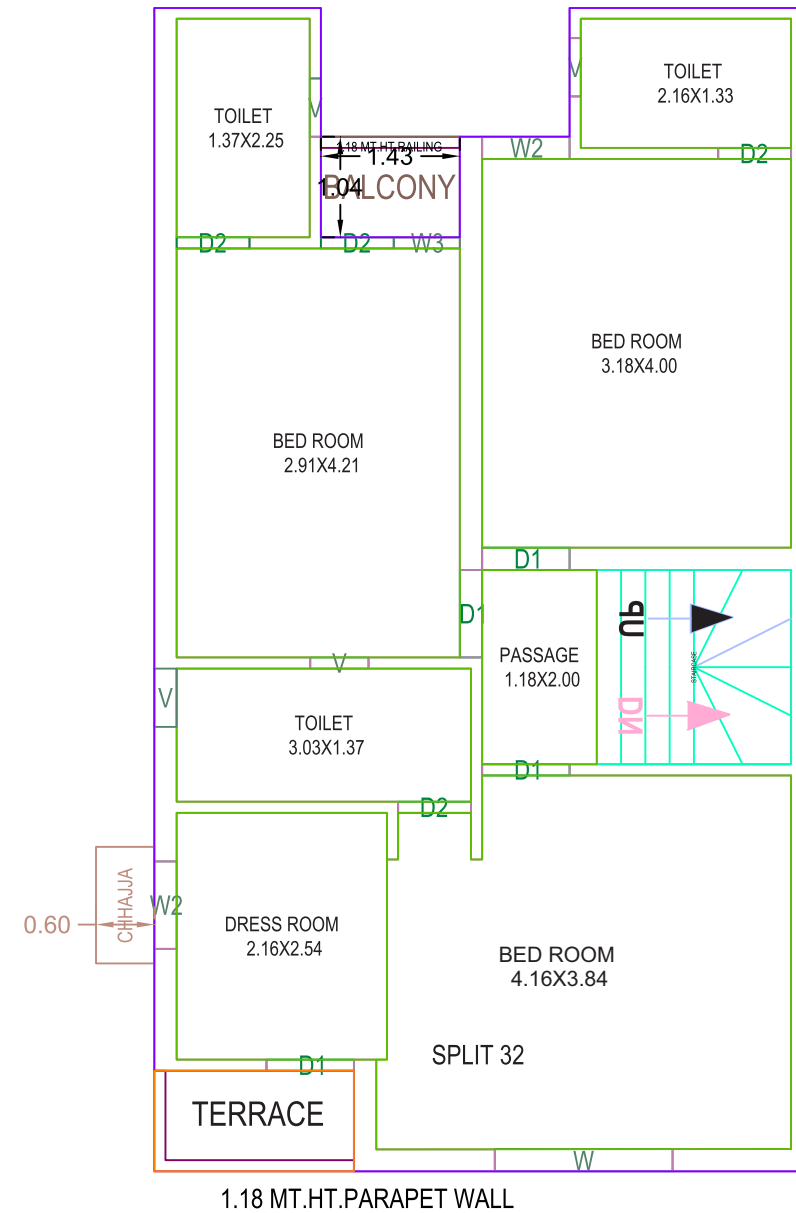

FIRST FLOOR PLAN

**UNIT PLAN
TYPE 33 (B-1)**

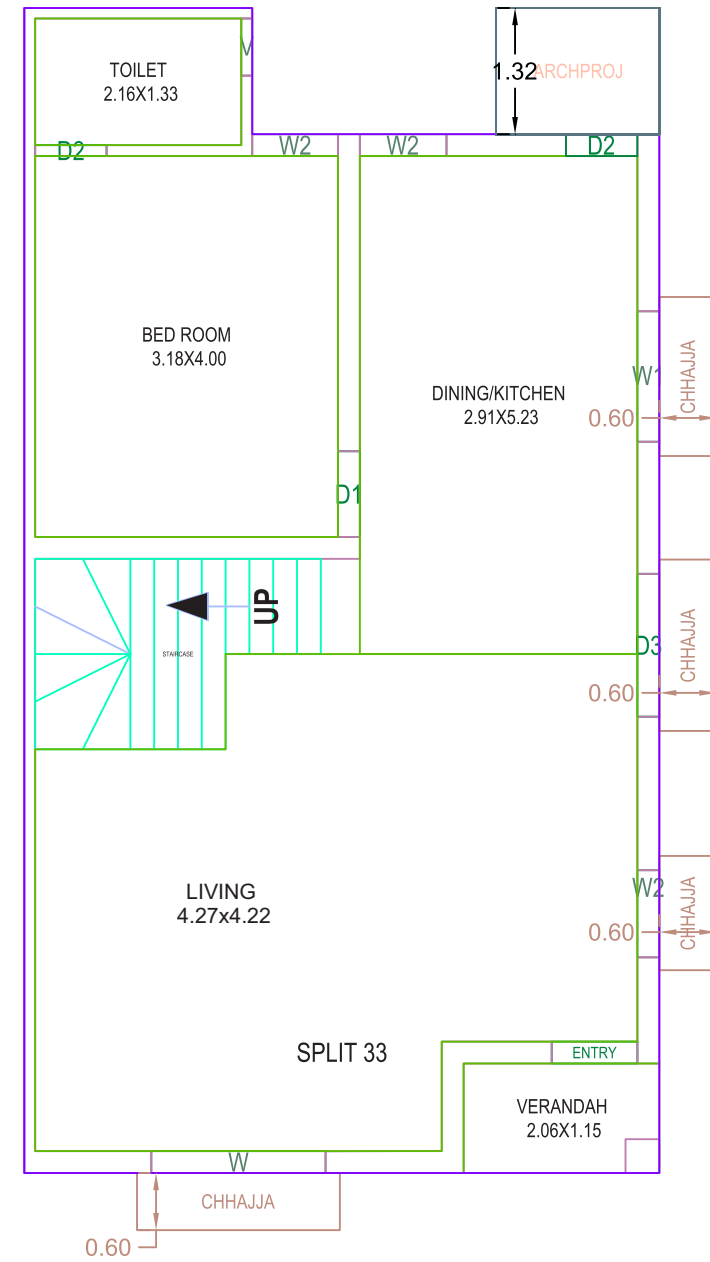

GROUND FLOOR PLAN

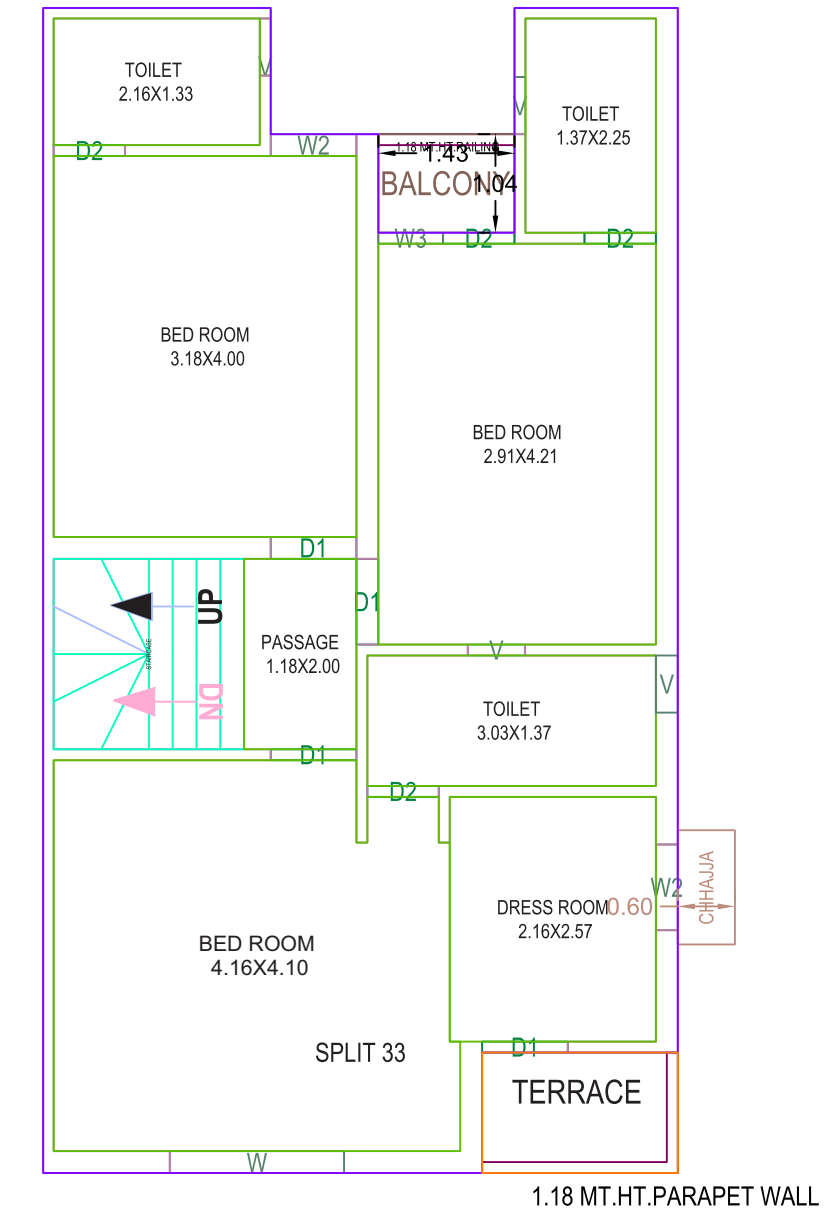

FIRST FLOOR PLAN

UNIT PLAN TYPE 34 (H-10)

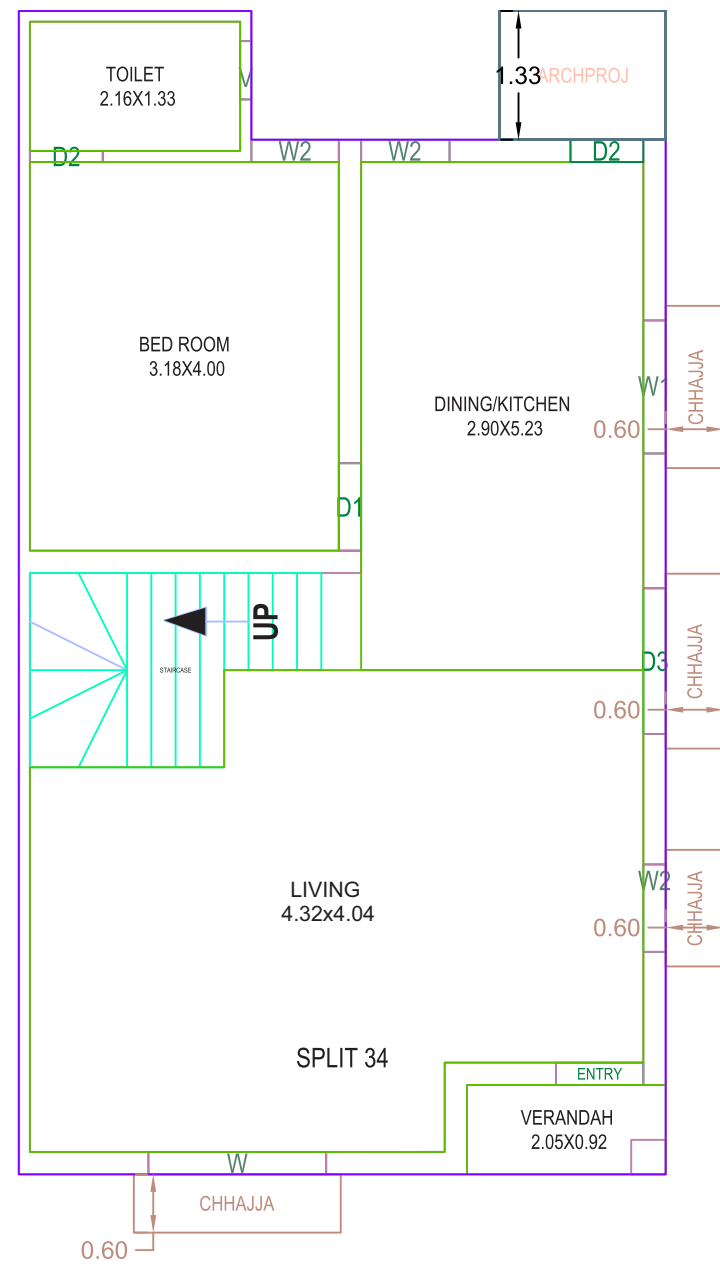

GROUND FLOOR PLAN

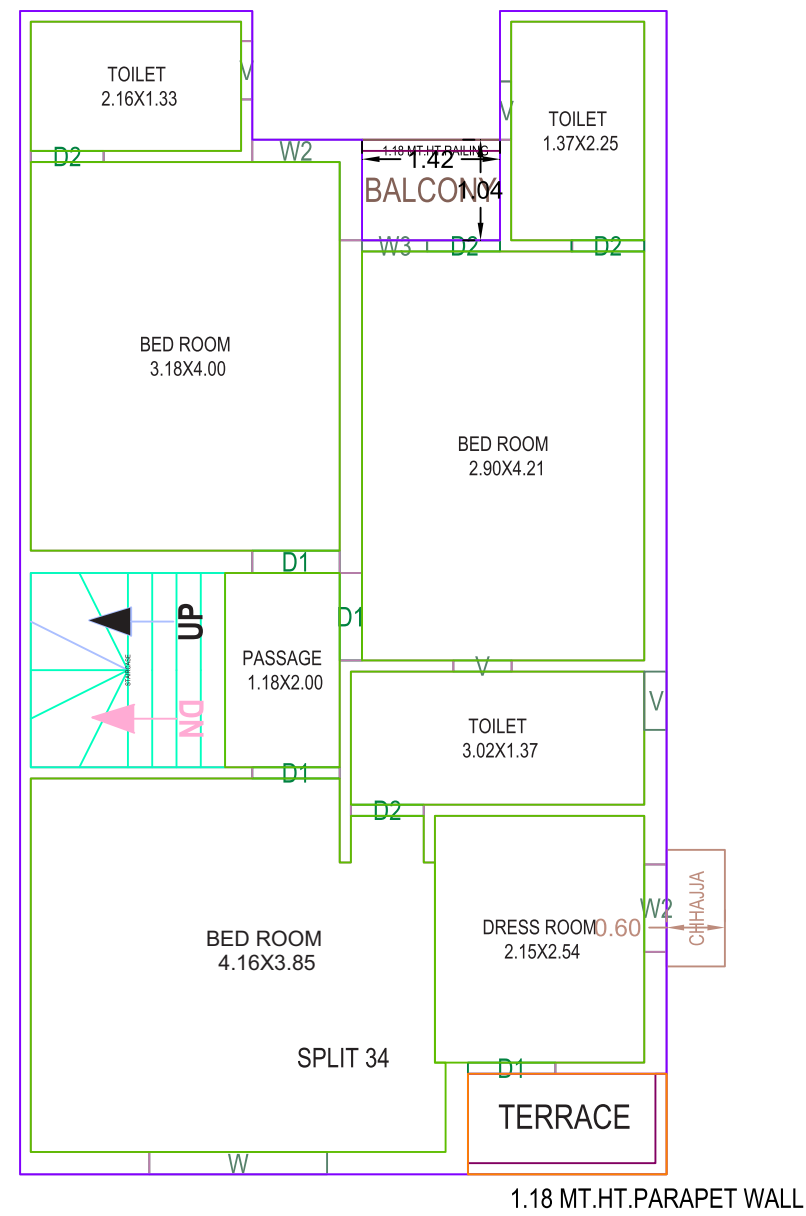

FIRST FLOOR PLAN

UNIT PLAN TYPE 35(H-1)

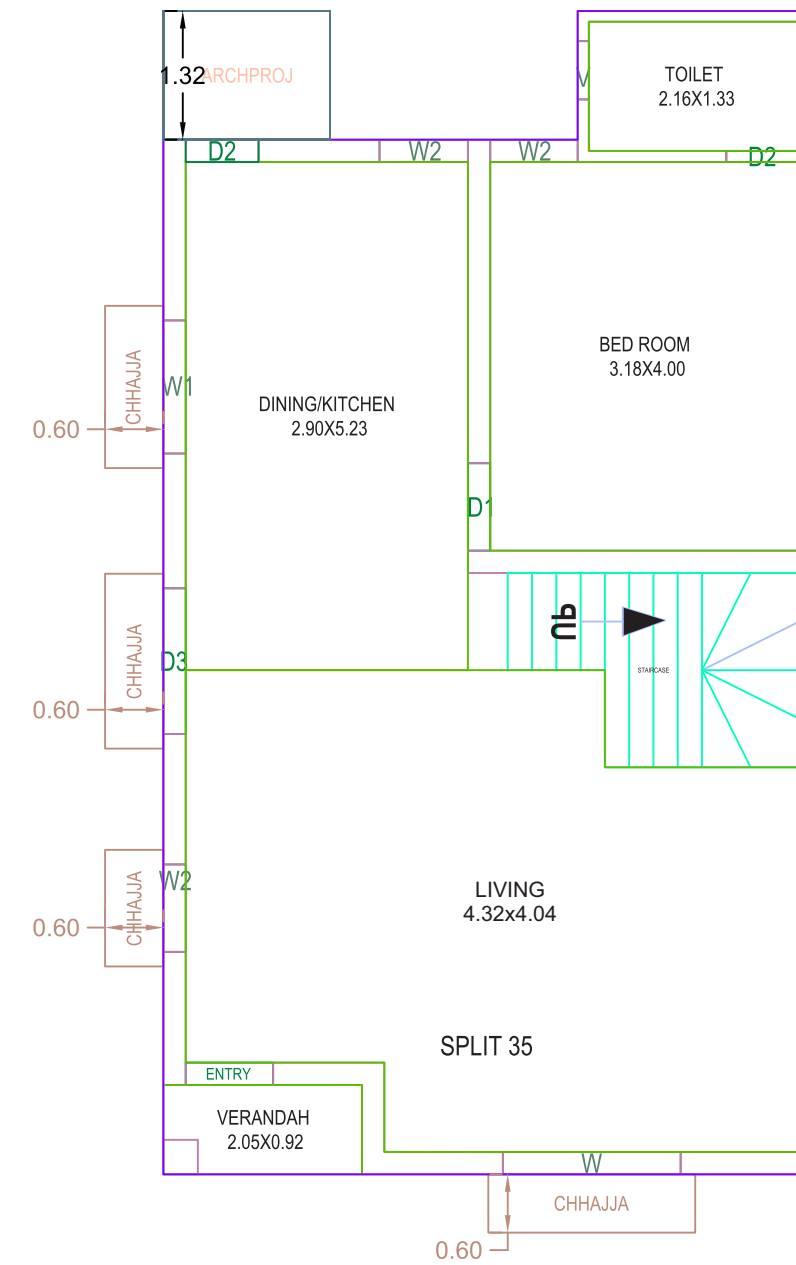

GROUND FLOOR PLAN

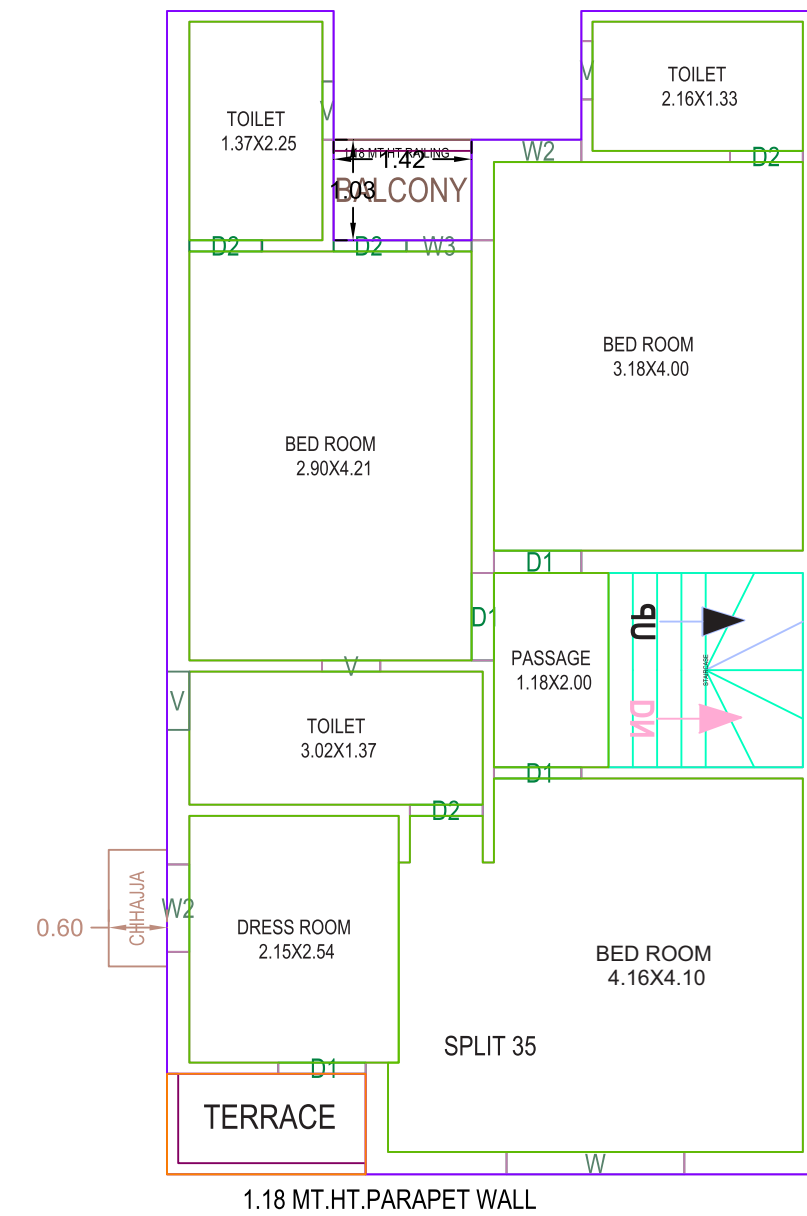

FIRST FLOOR PLAN

**UNIT PLAN
TYPE 36 (G-10)**

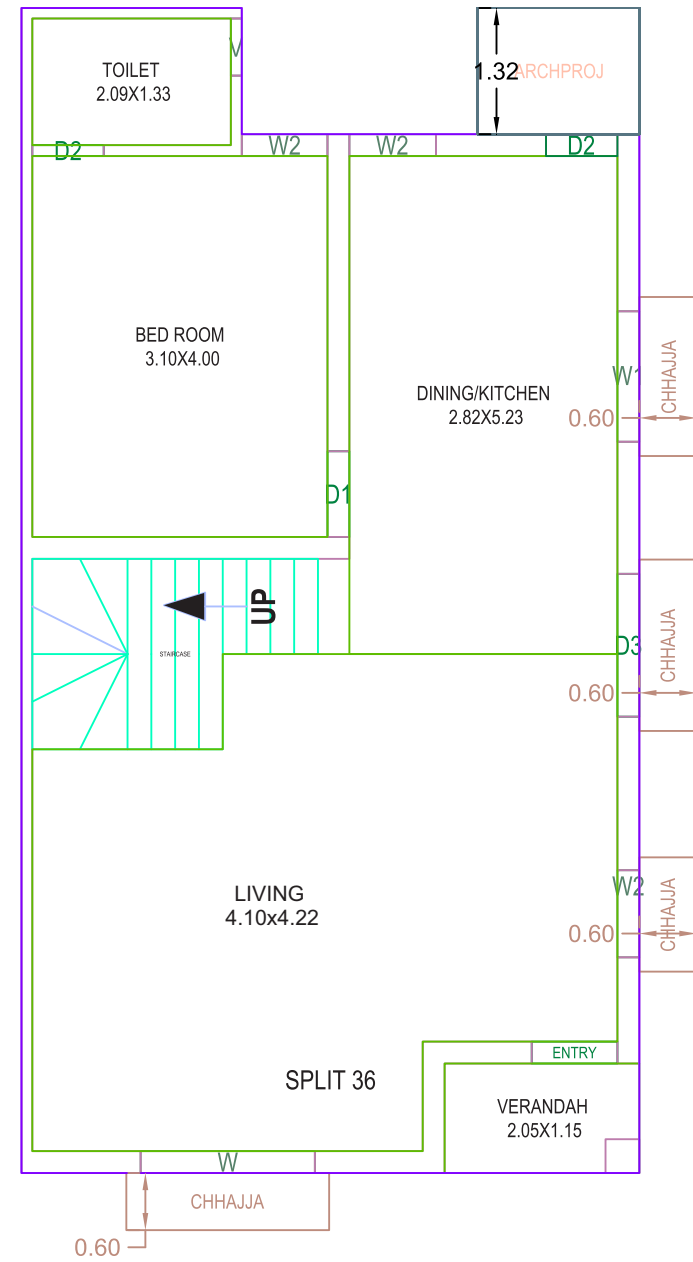

GROUND FLOOR PLAN

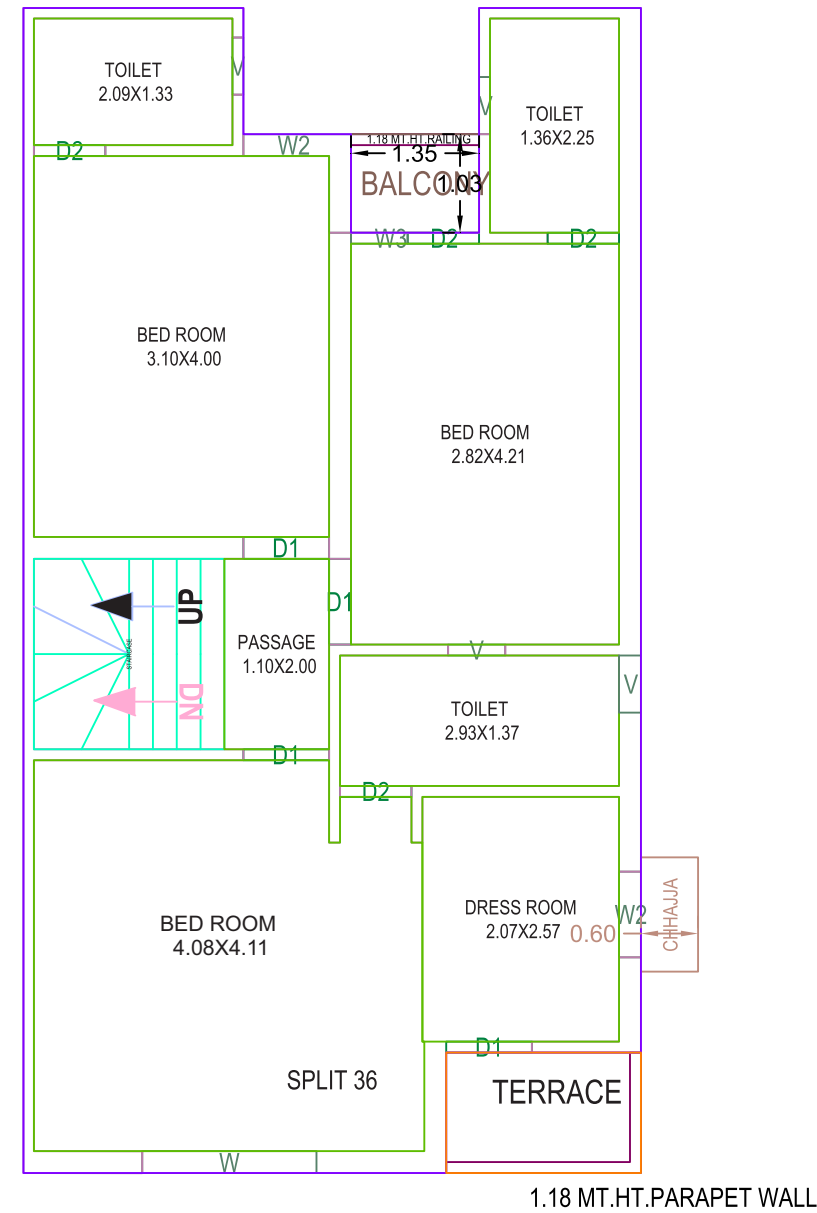

FIRST FLOOR PLAN

**UNIT PLAN
TYPE 37 (G-1)**

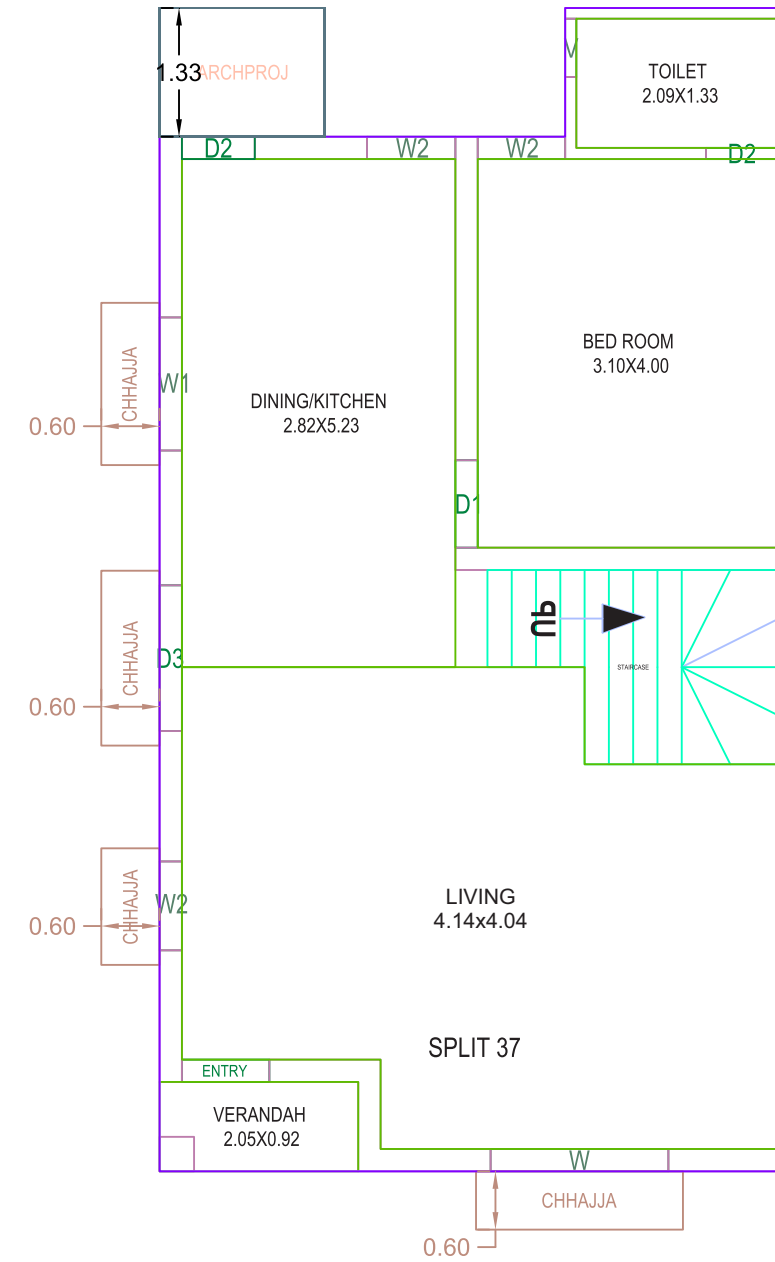

GROUND FLOOR PLAN

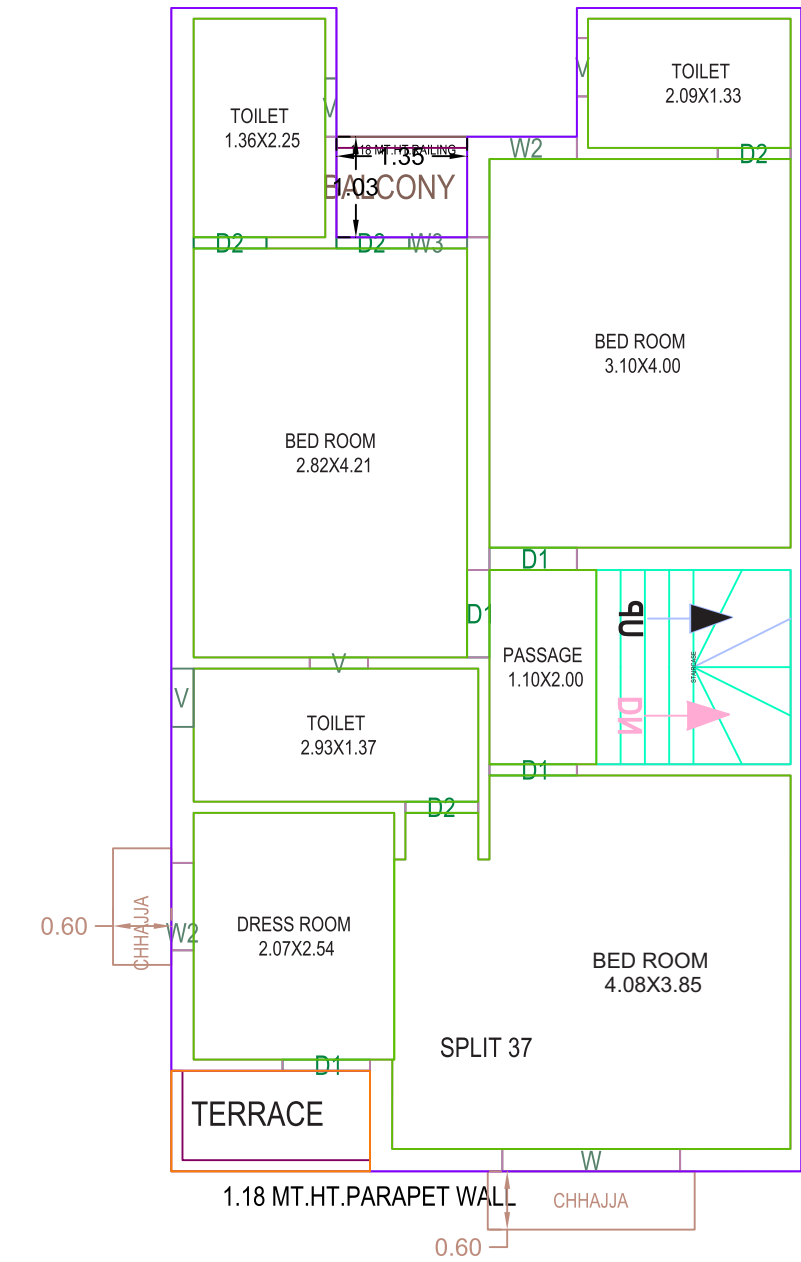

FIRST FLOOR PLAN

UNIT PLAN TYPE 38 (A-14,J-1)

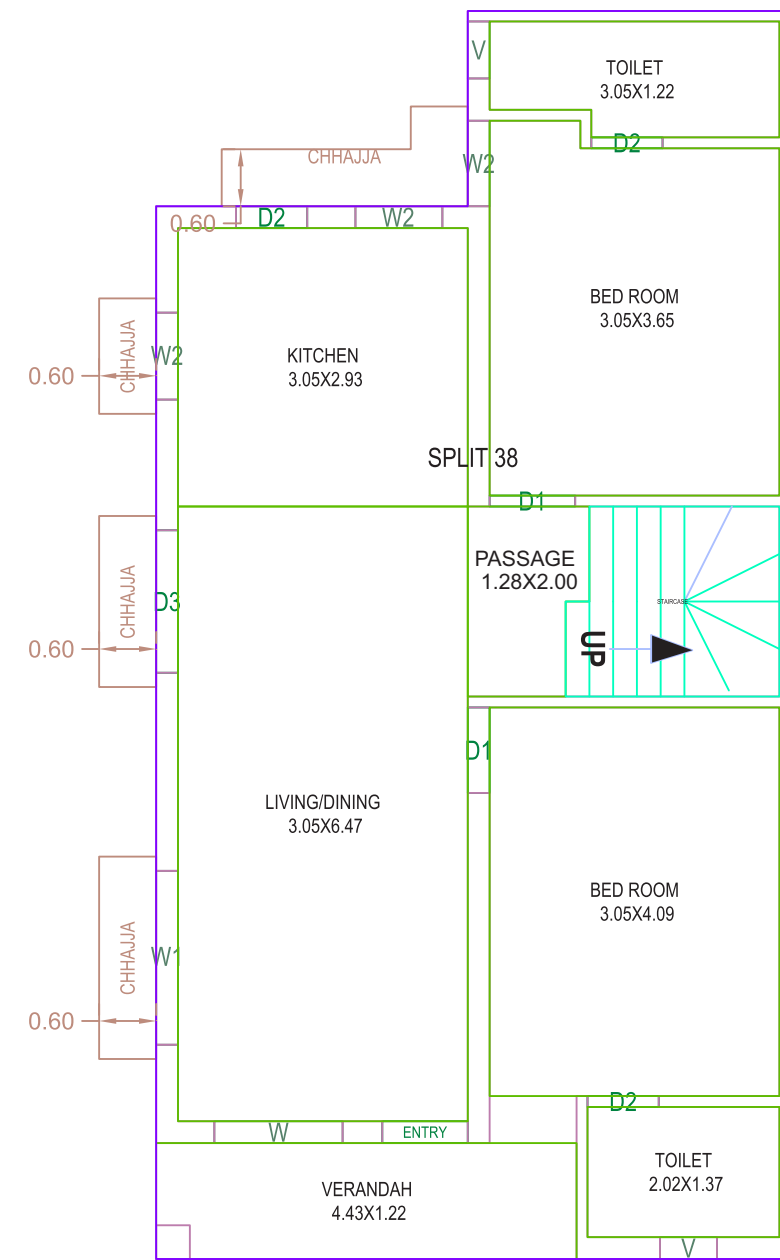

GROUND FLOOR PLAN

UNIT PLAN TYPE 39 (J-12)

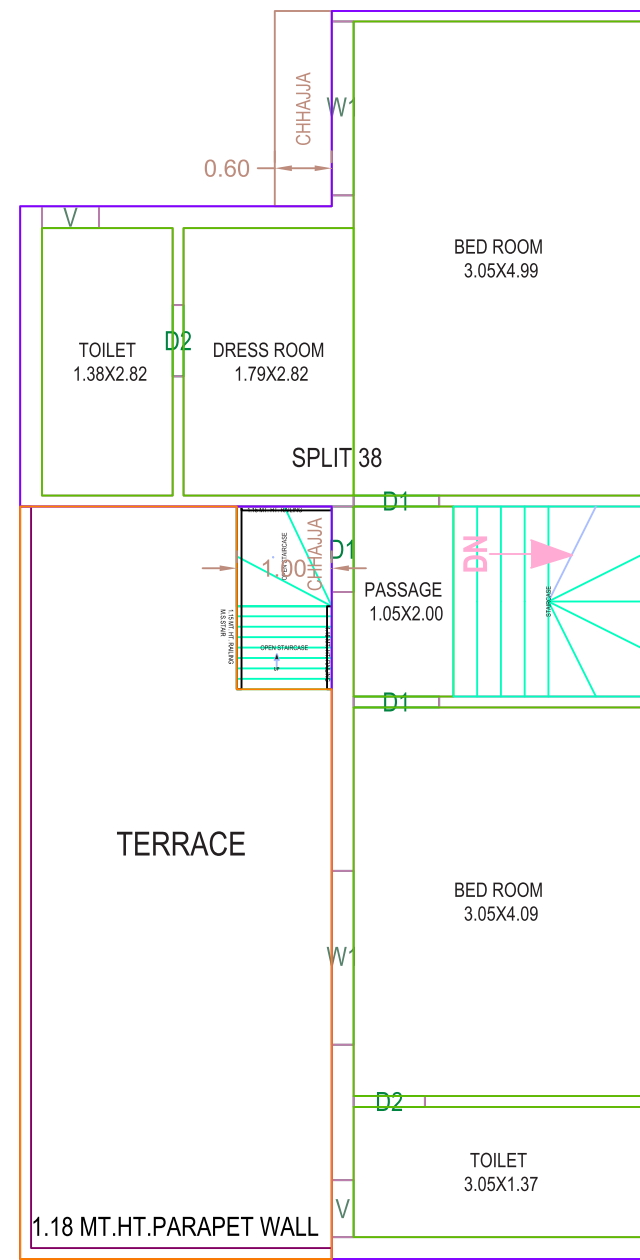

FIRST FLOOR PLAN

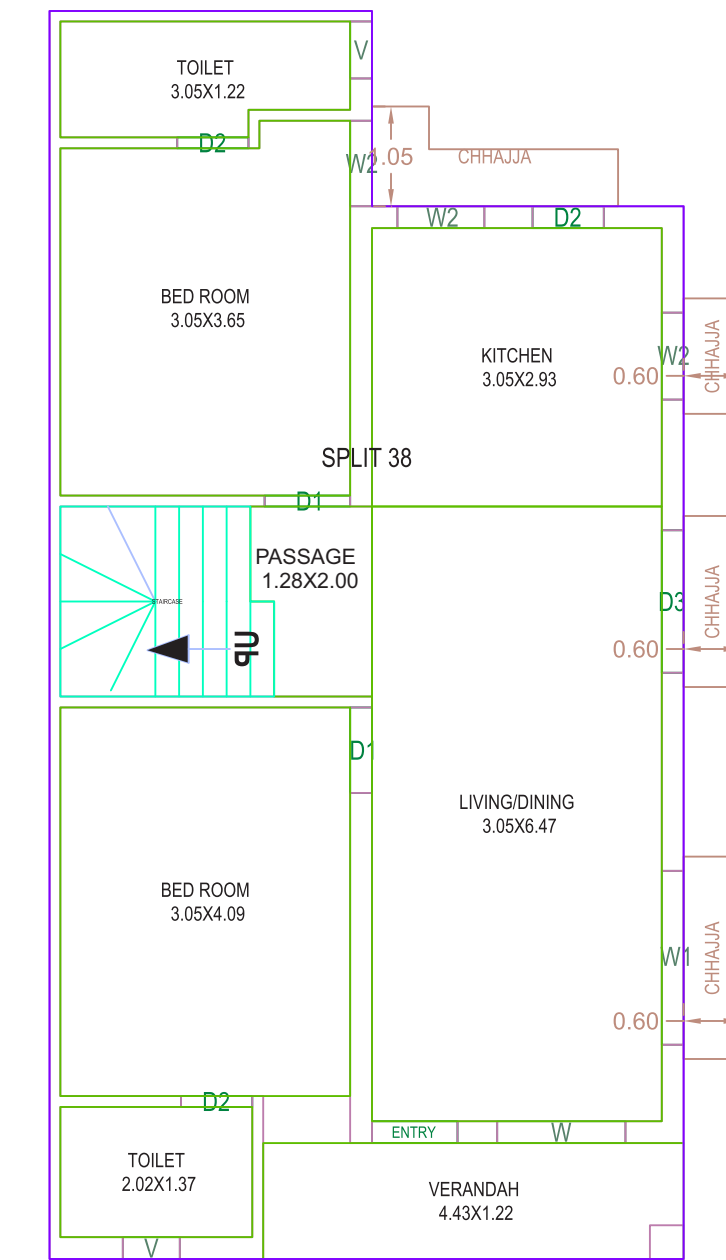

GROUND FLOOR PLAN

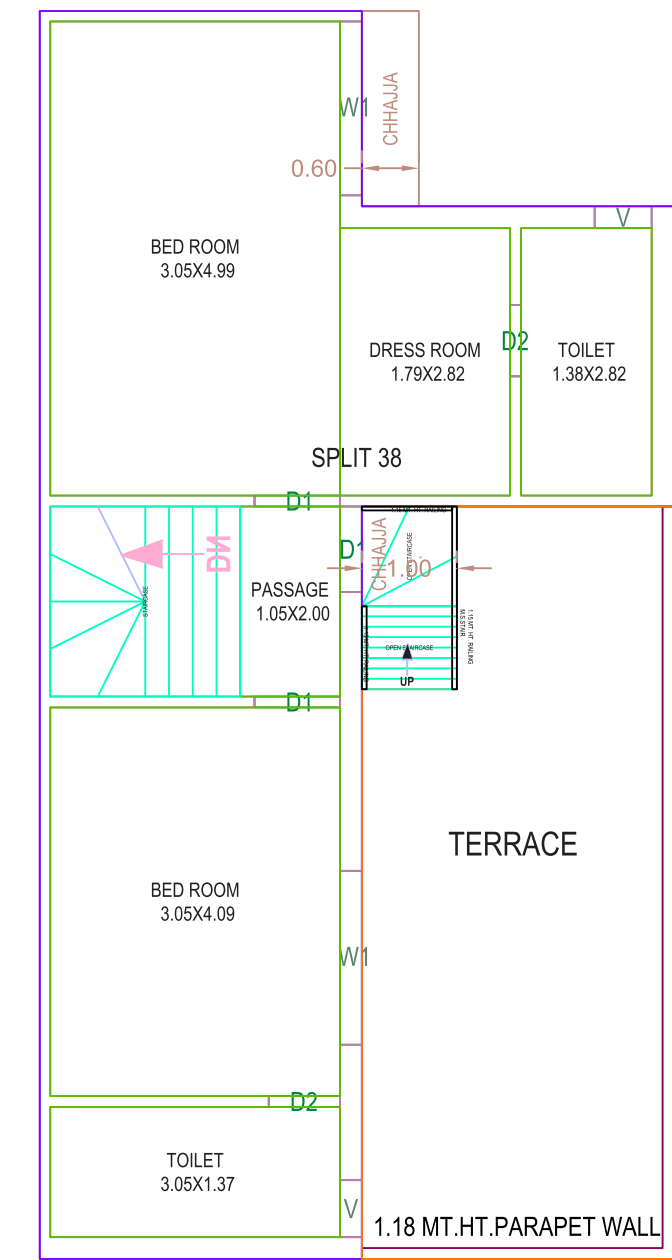

FIRST FLOOR PLAN

UNIT PLAN TYPE 40 (A-1)

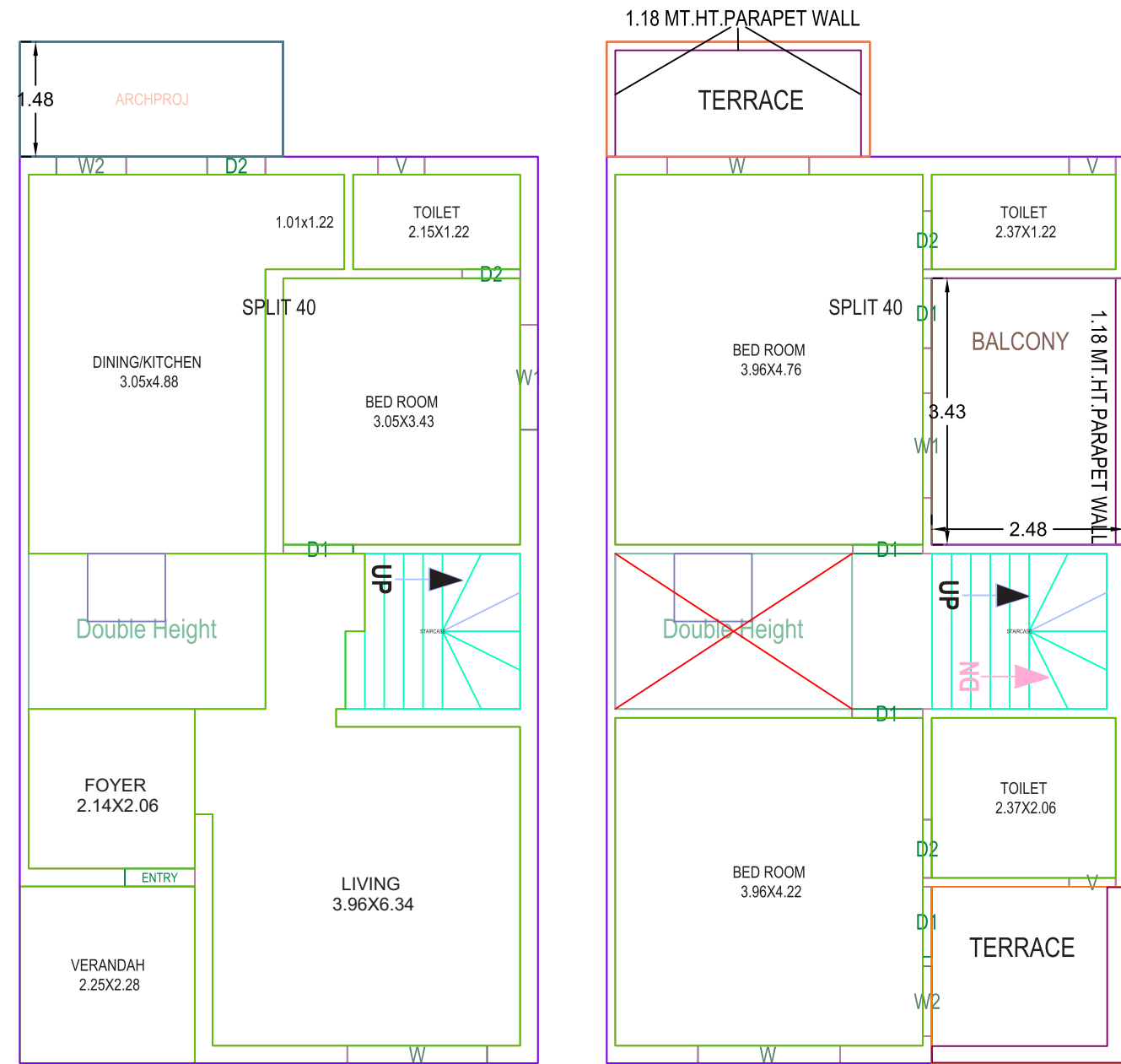

GROUND FLOOR PLAN

FIRST FLOOR PLAN

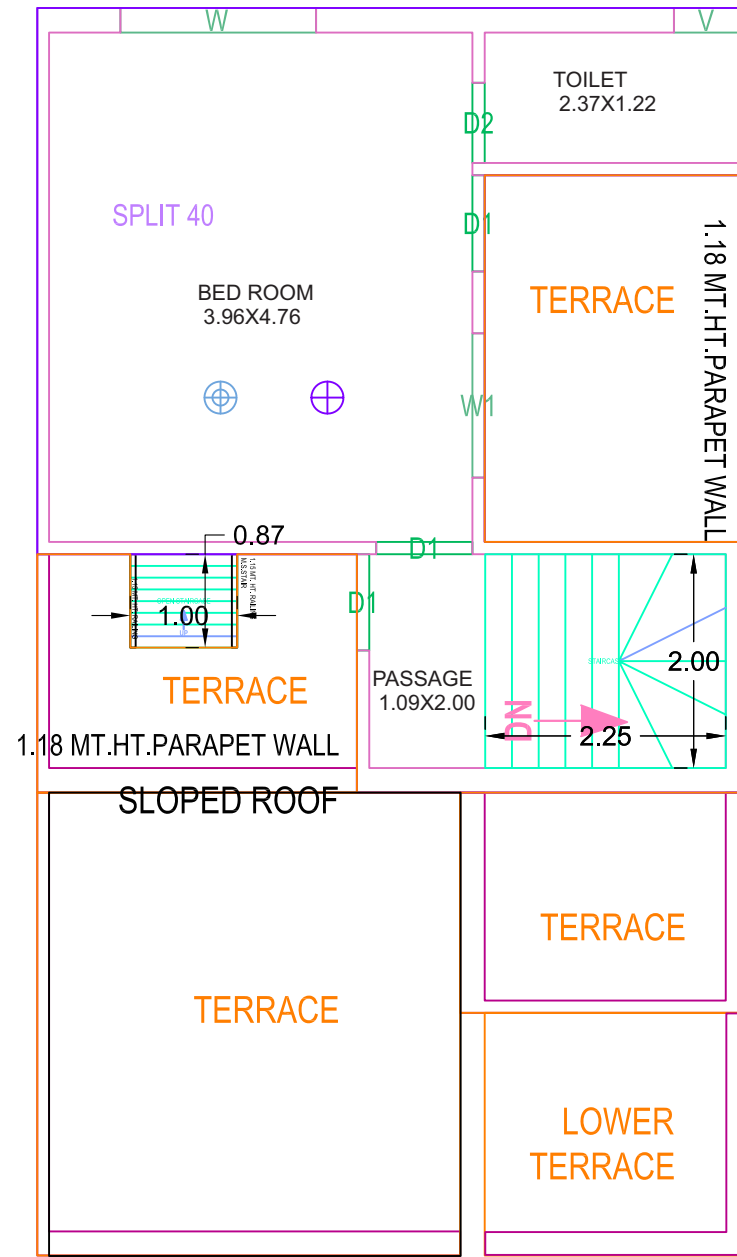

SECOND FLOOR PLAN

UNIT PLAN TYPE 41 (G-5,H-5,I-5)

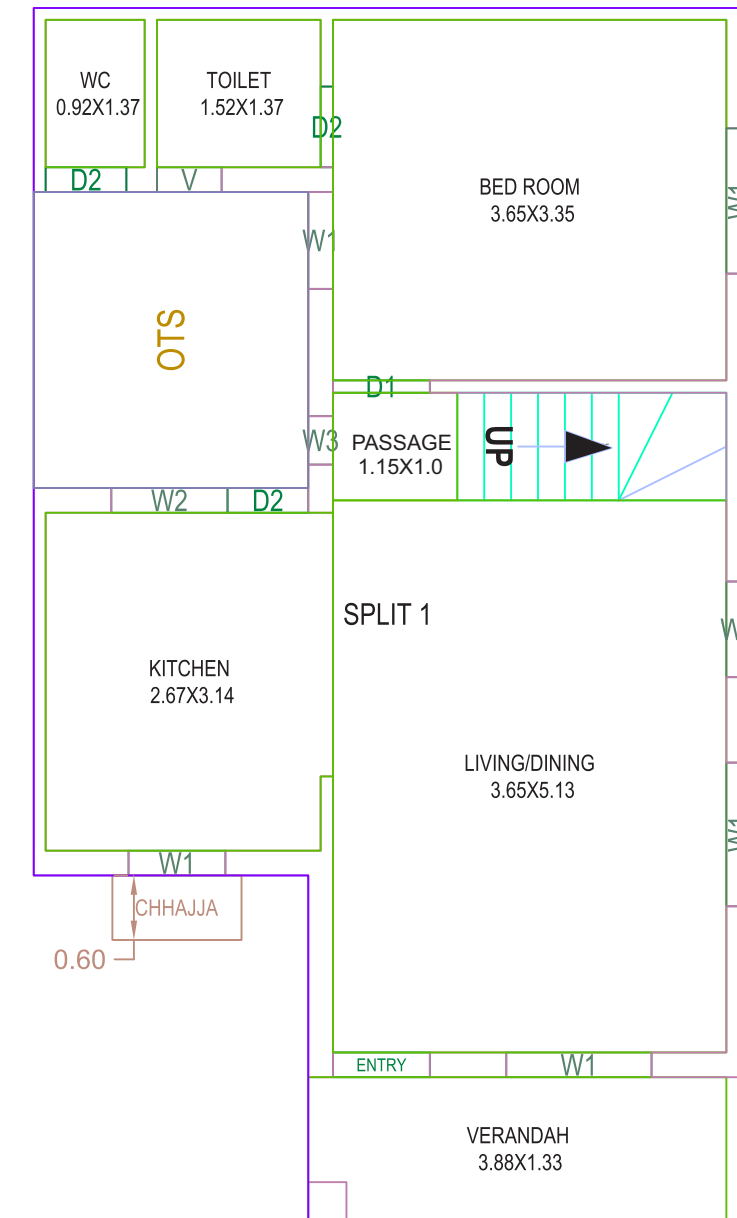

GROUND FLOOR PLAN

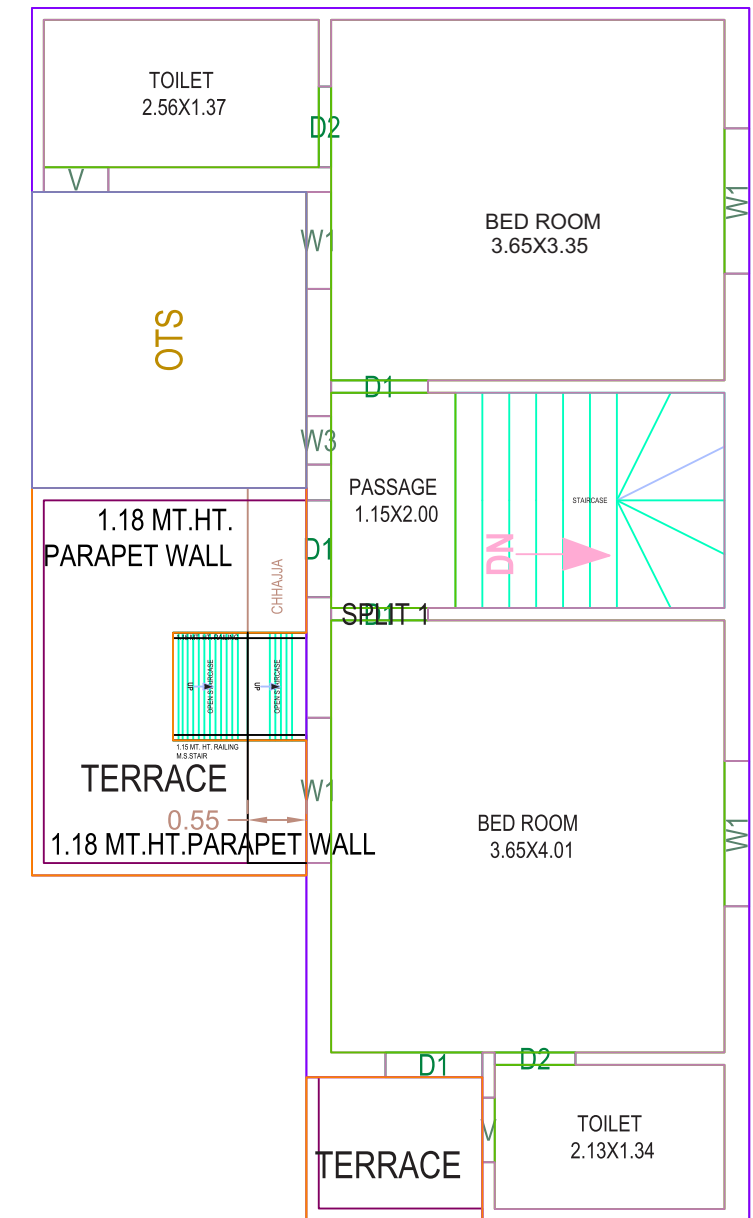

FIRST FLOOR PLAN

**UNIT PLAN
TYPE 42 (H-6,I-6)**

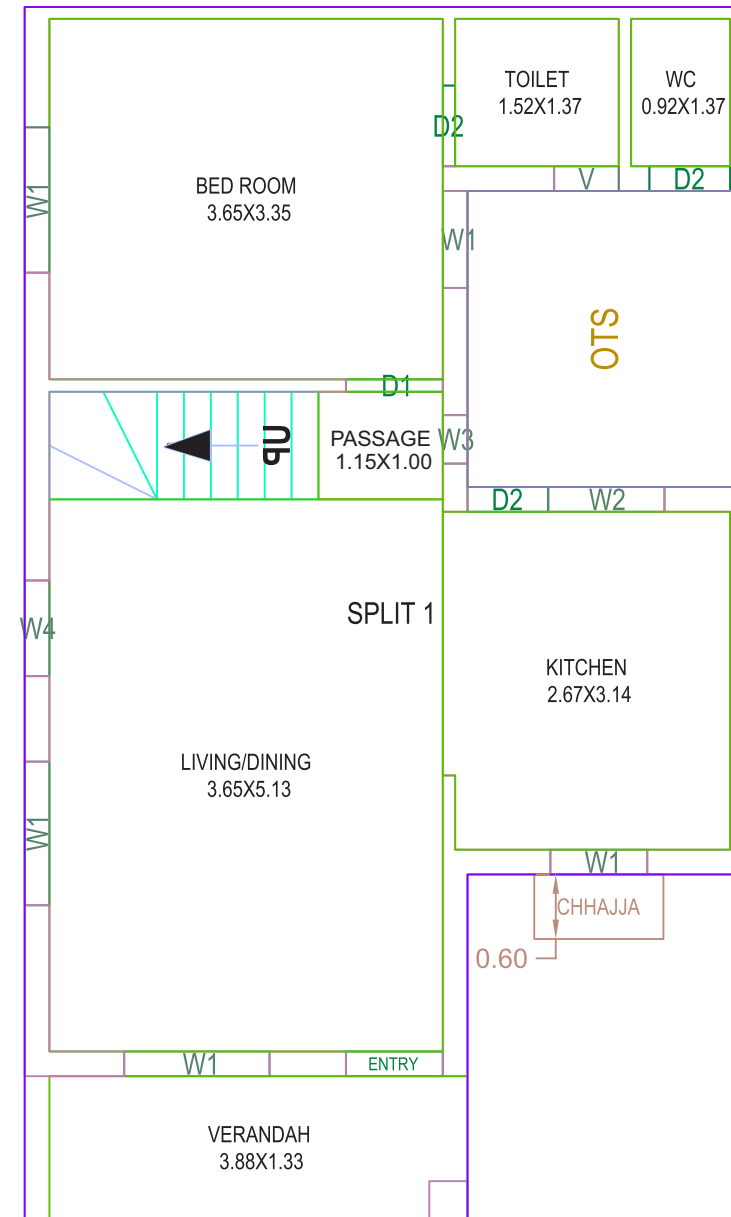

GROUND FLOOR PLAN

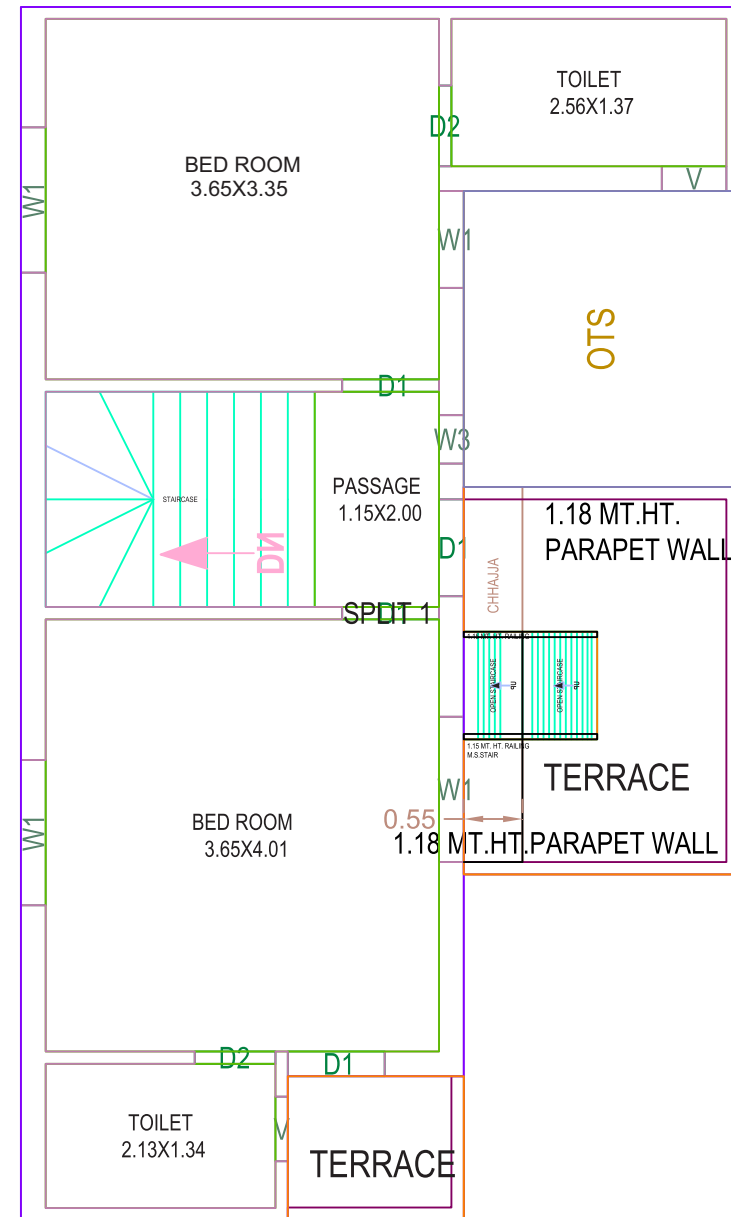

FIRST FLOOR PLAN

**UNIT PLAN
TYPE 43 (G-6)**

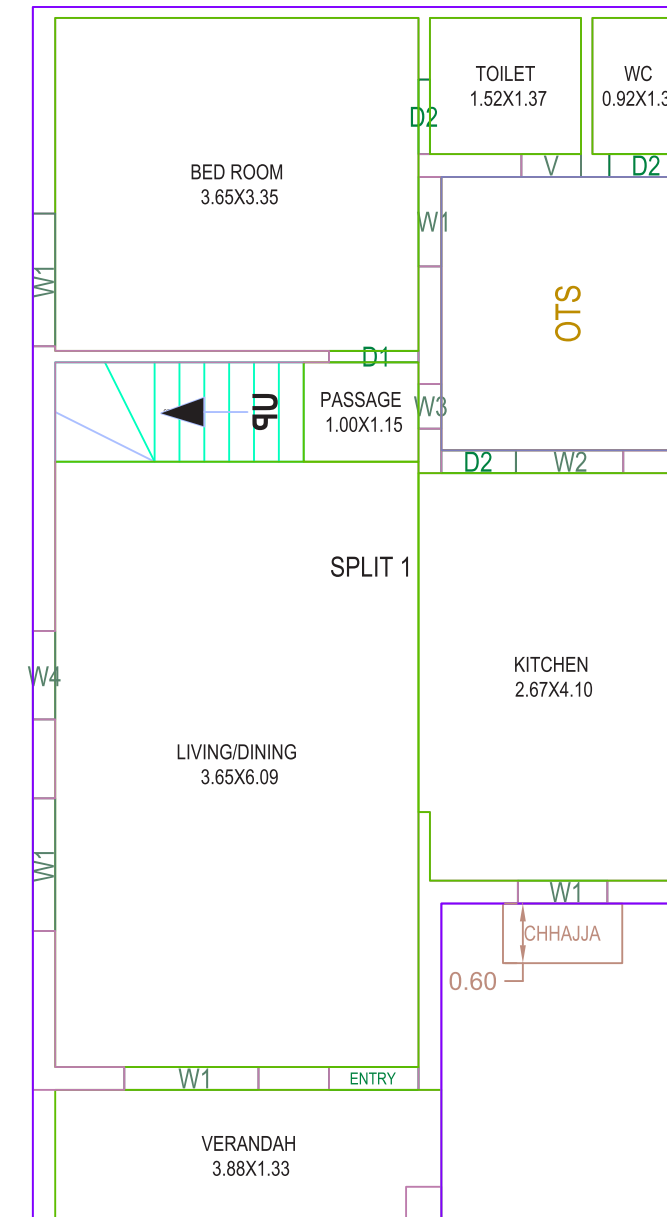

GROUND FLOOR PLAN

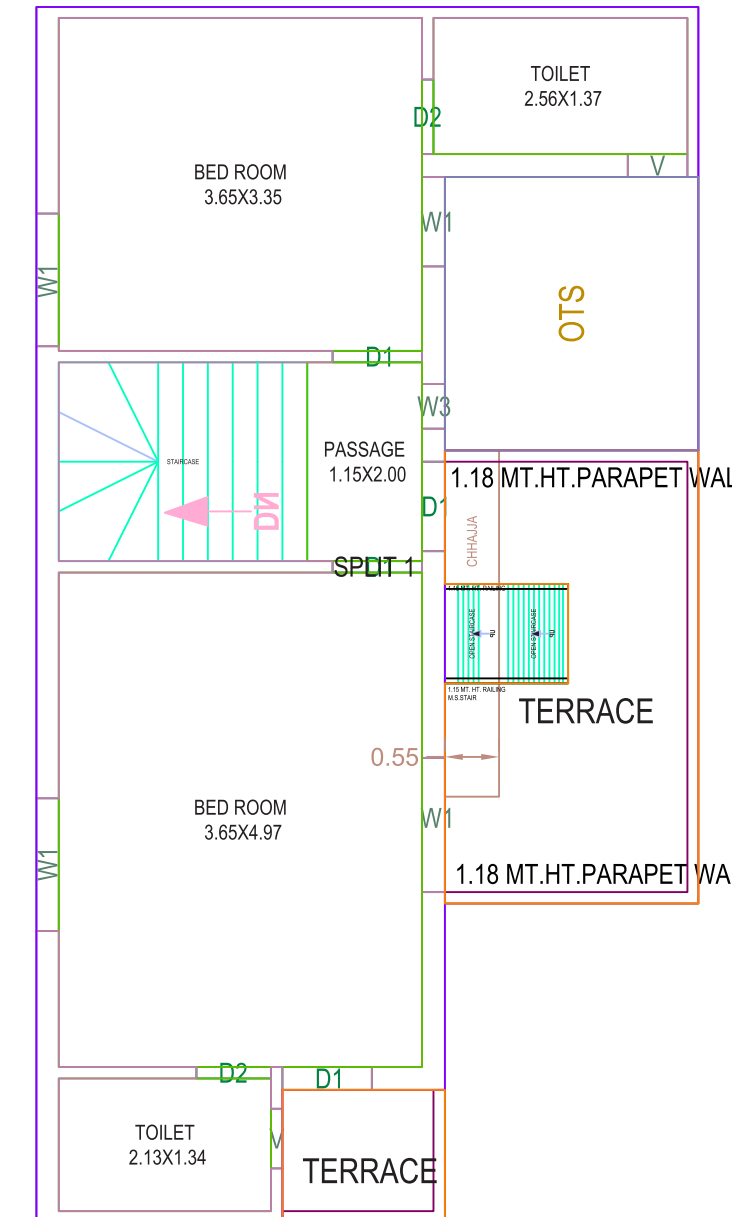

FIRST FLOOR PLAN

SPECIFICATION

- બાંધકામ
વેધરપ્રુફ કલર સાથેનું બાહ્ય પ્લાસ્ટર
સ્મૂથ ફિનિશ પ્લાસ્ટર અને વોલપુટ્ટી ફીનીશ સાથેની આંતરિક દીવાલ
સ્લોપીંગ રૂફમાં ફેબ્રિકેશન ફેમ કરી નળીયા લગાવી આપવામાં આવશે.
- ફ્લોરીંગ
બધા રૂમ અને રસોડામાં માનક ગુણવત્તાવાળી વિટ્રિફાઇડ ટાઇલ્સ ફ્લોરીંગ
બધા બાથરૂમ અને રસોડામાં લિન્ટલ લેવલ સુધી સીરામીક ટાઇલ્સનો ડેડો લગાવામાં આવશે.
રસોડામાં ગ્રેનાઇટ પ્લેટફોર્મ
- દરવાજા અને બારીઓ
બ્રાન્ડેડ લોક સાથેનો આકર્ષક મુખ્ય દરવાજો અને અન્ય લાકડાના દરવાજા
એલ્યુમીનીયમ ફેમ સાથેની કાચની બારીઓ
- પ્લમ્બિંગ
તમામ બાથરૂમમાં કંસીલ PVC પ્લમ્બિંગ અને બ્રાન્ડેડ CP ફીટીંગ્સ લગાવામાં આવશે.
- ઇલેક્ટ્રીકને લગતુ કામ
કંસીલ સેફ્ટી વાળું કોપર વાયરિંગ સાથે બ્રાન્ડેડ કંપનીની એક્સેસરીઝ

AMENITIES

- ક્લબ હાઉસ
- બાળકો માટે રમવાની જગ્યા
- કોન્ક્રીટ રોડ
- સ્ટ્રીટ લાઇટ
- નાગરીકો માટે બેસવાની વ્યવસ્થા
- લેન્ડસ્કેપ ગાર્ડન
- અંડર ગ્રાઉન્ડ ઇલેક્ટ્રીક સીટી સપ્લાય

DEVELOPER :



AMRUT
INFRACON LLP

ARCHITECT :



6th
design studio

STRUCTURE ENGINEER :

ANKITBHAI
MISTRY

SITE ADDRESS

OM COURTYARD

Turn From - Railway Bridge / Hotel Anand Palace,
Nr. Hathijan Circle, Vinzol, Ahmedabad- 382445.

નોંધ :

- Specification માં આર્કિટેક ડિઝાઇન મુજબ ફેરફારને પાત્ર છે.
- ઉપર લખેલ તમામ Specification અને Amenities માં ફેરફાર કરવાના તમામ હક્કો રેવલોપર પાસે રહેશે.



SCAN FOR
LOCATION

